

Proper NMEA 2000 Installation IBEX 2012 Session 813

Part I

Physical Installation

Dave Morschhauser, Mystic Valley Communications

Pete Braffitt, Gemeco

Overview

- What is NMEA 2000?
- What are its physical characteristics and limits?
- What makes a good NMEA 2000 network?
- What makes a good NMEA 2000 network fail?

NMEA 2000

- Marine specific network for navigation, control, and monitoring
- CAN based, similar to J1939
- Uses industrial quality cabling originally developed for DeviceNET
- Certified products, based on standard certification tool

NMEA 2000 Certification

- First certification program applicable to recreational marine electronic products
- Over 400 products certified to date
- Purpose: ensure products communicate cooperatively (plug and play)
- Based on common certification tool
- Cabling components are also approved

NMEA 2000

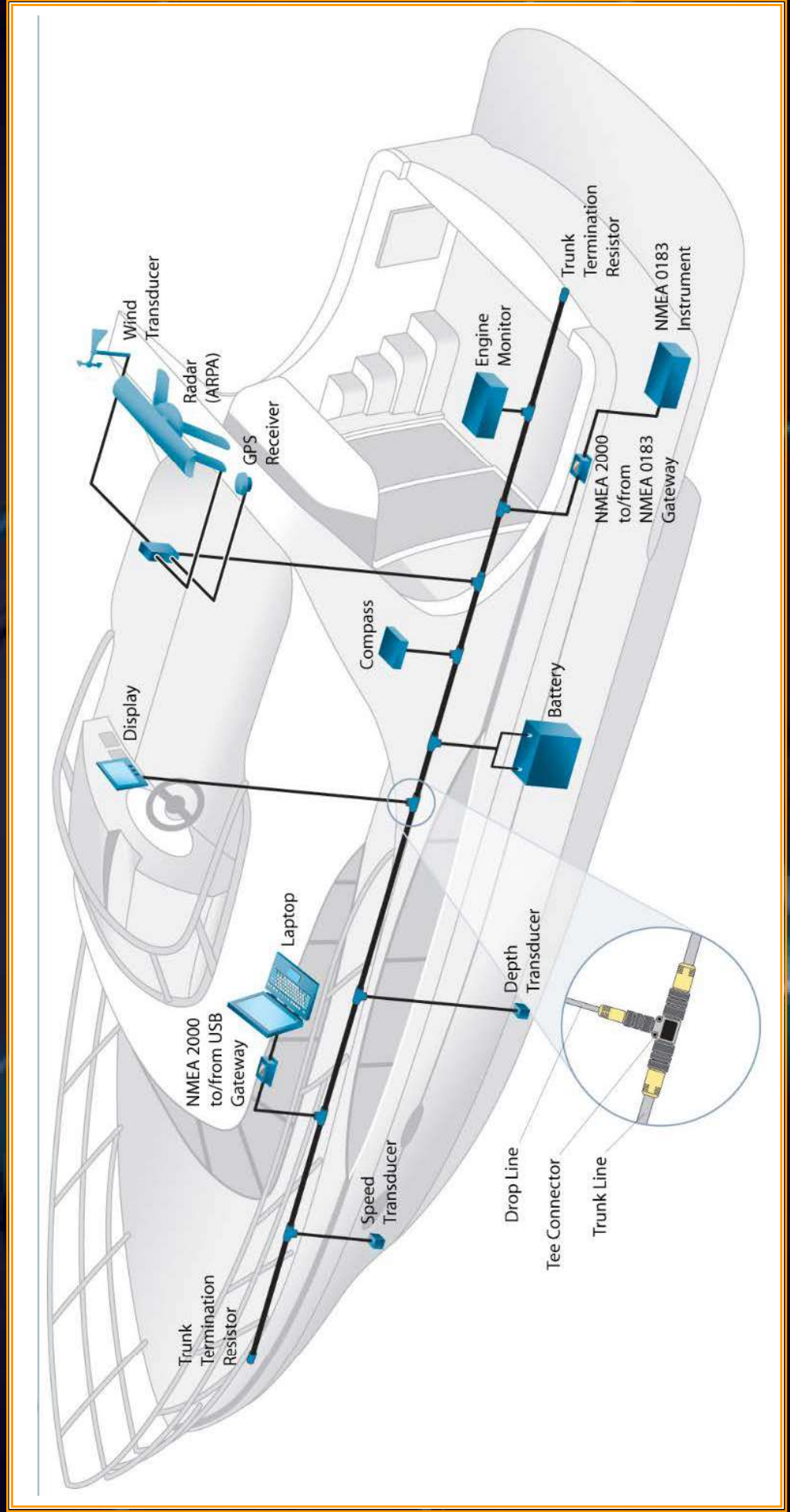

Typical Tee



**FEMALE
Backbone
Connection**

**MALE
Backbone
Connection**

Drop Connection to device (FEMALE)- Accepts drop cable.

NMEA 2000

- Single backbone cable snakes throughout the vessel
- No active network infrastructure to fail
- Standardized message structure and format
 - both generic and system specific messages
- Links vessel systems together
 - engines, navigation, power distribution, water & waste, etc.

NMEA 2000 = Vessel Database



What can you do with NMEA 2000?



Physical Construction

- Building Blocks
- Characteristics
- Power Availability
- Other considerations

NMEA 2000 Building Blocks

Power Tee(s)

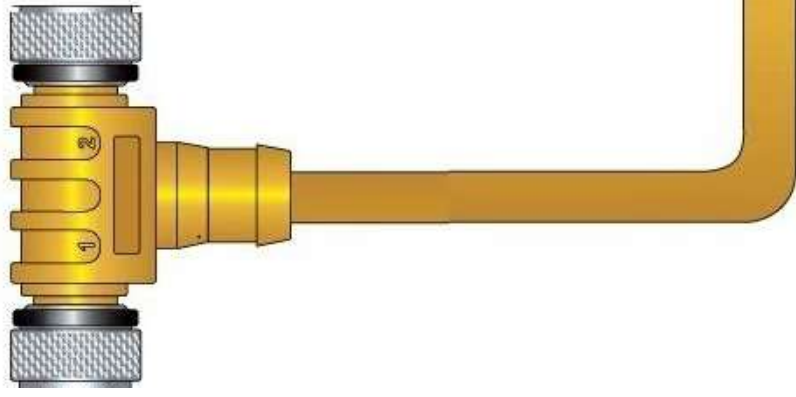

Tee Connectors



Termination Resistors



Backbone & Drop Cables



NMEA 2000 Building Blocks



Mini to Micro
Adapter



Field Installable
Connectors



Gender
Changer

Mini Backbone
w/ Micro Drop



NMEA 2000 Characteristics

Overall:

- Capacity - 250K bits-per-second
- Interface operating range - 9 to 15 volts
- Logical network identities - 252
- Minimum node separation - 0 meters
- Maximum bridged backbones - 10

NMEA 2000 Characteristics

Each backbone:

- Length - 200 meters
 - 100 meters when using light cable
- Connected products - 50
- Drop cable
 - 6 meters per drop
 - 78 meters total of all drops
- Power - limited by cable size and the number of power insertion points

NMEA 2000 Terminology

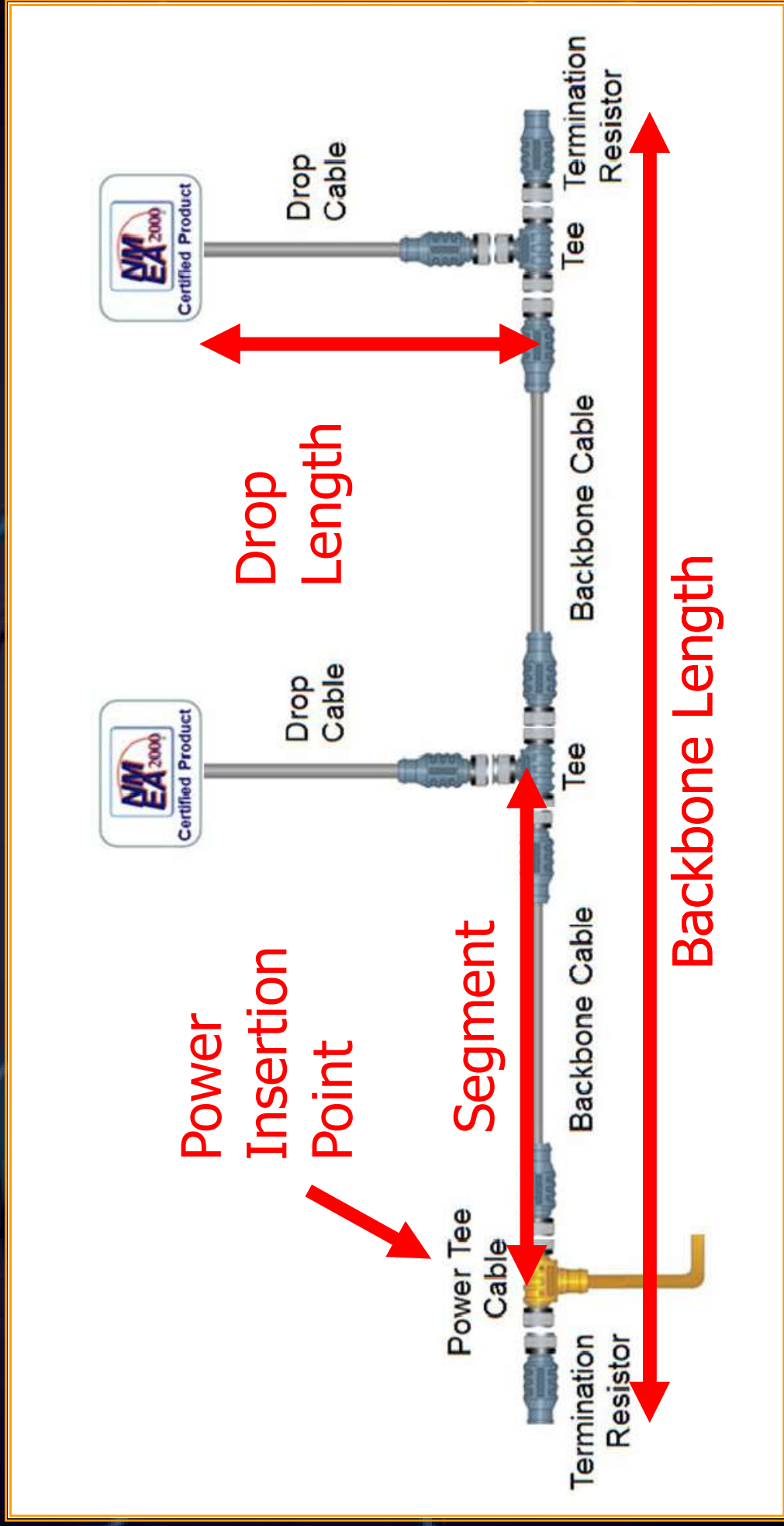

Cable Construction

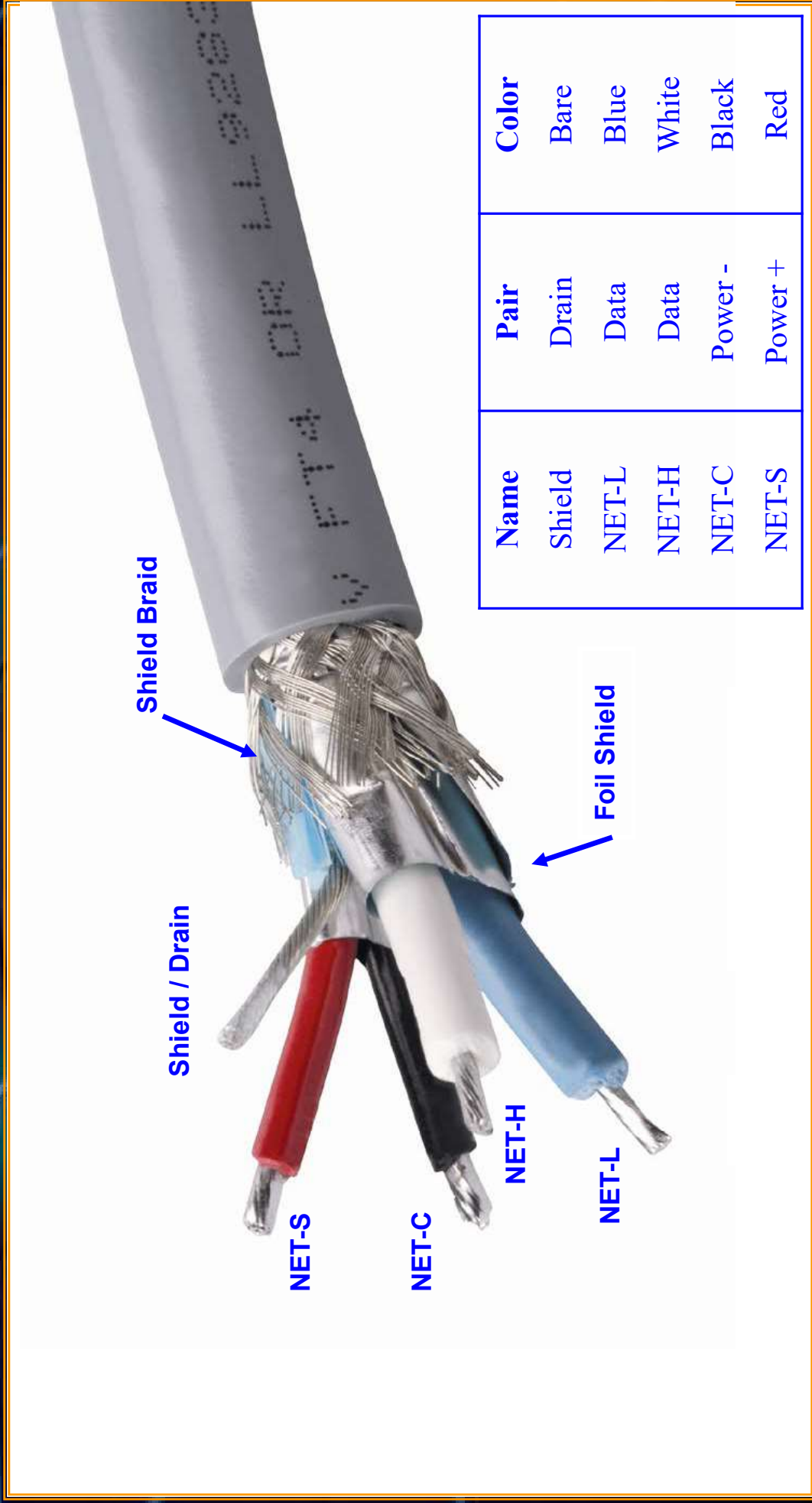

Name	Pair	Color
Shield	Drain	Bare
NET-L	Data	Blue
NET-H	Data	White
NET-C	Power -	Black
NET-S	Power +	Red

Product Power Sources

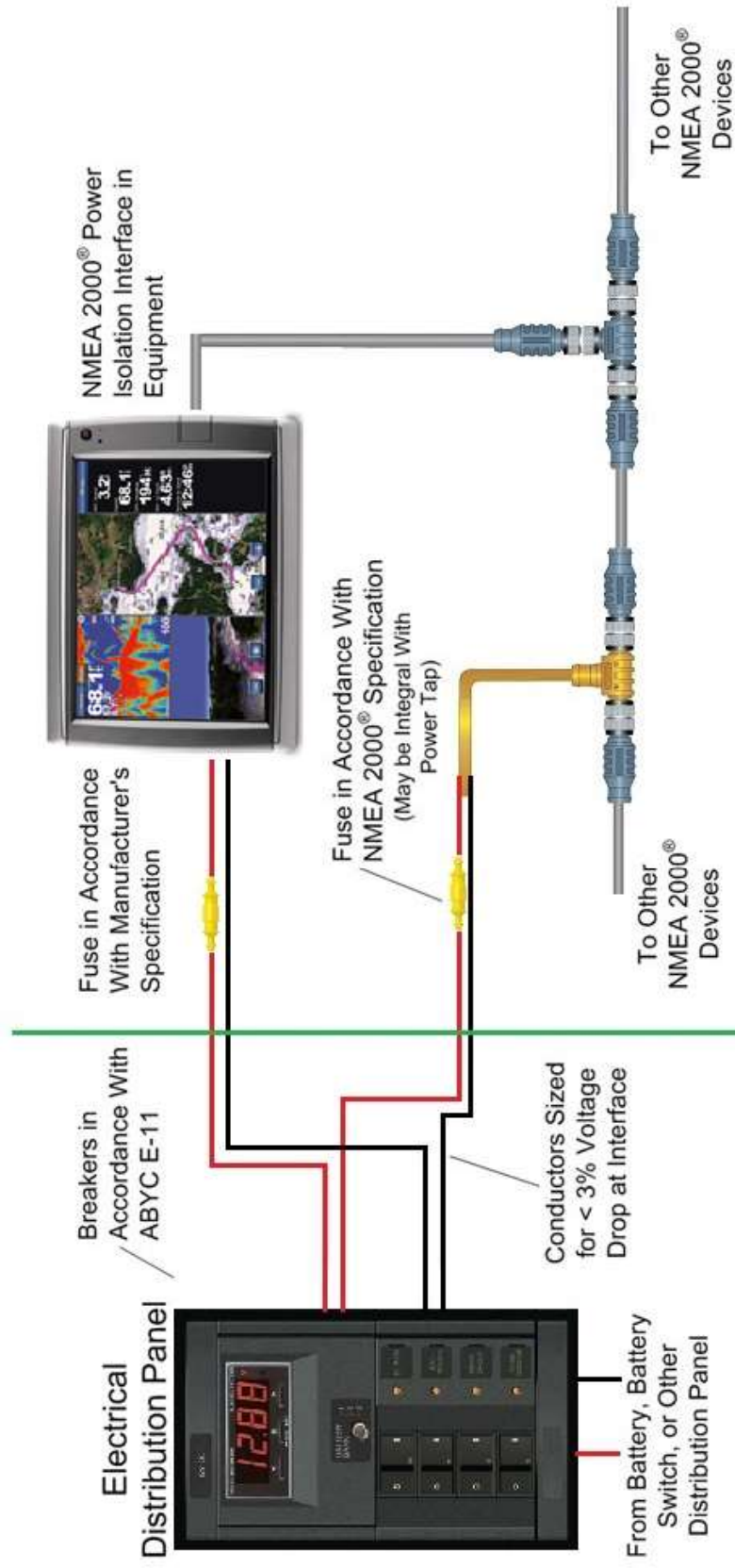

ABYC E-11 NMEA 2000®

Power Distribution Communications Interface

Cable Types

Style	Light	Mid	Heavy
Connectors	Micro	Micro/Mini	Mini
Max Length	100 meters	200 meters	200 meters
Capacity	3 amp*	4/8 amp*	8* amp
Signal Wire Gage	24 AWG	20 AWG	18 AWG
Power Wire Gage	22 AWG	16 AWG	16AWG

* Maximum power per backbone segment

NMEA 2000 Backbone

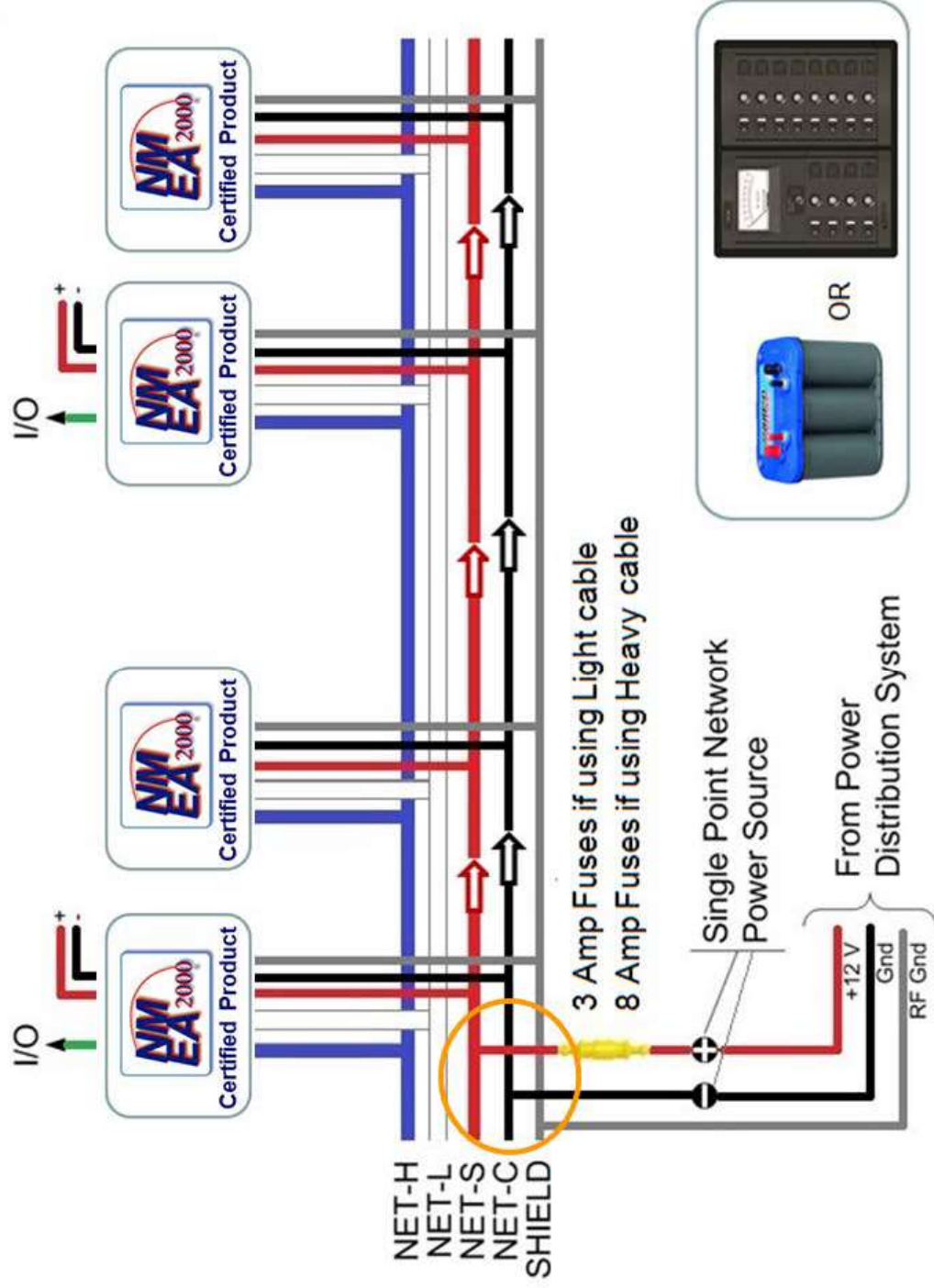

NMEA 2000 Backbone

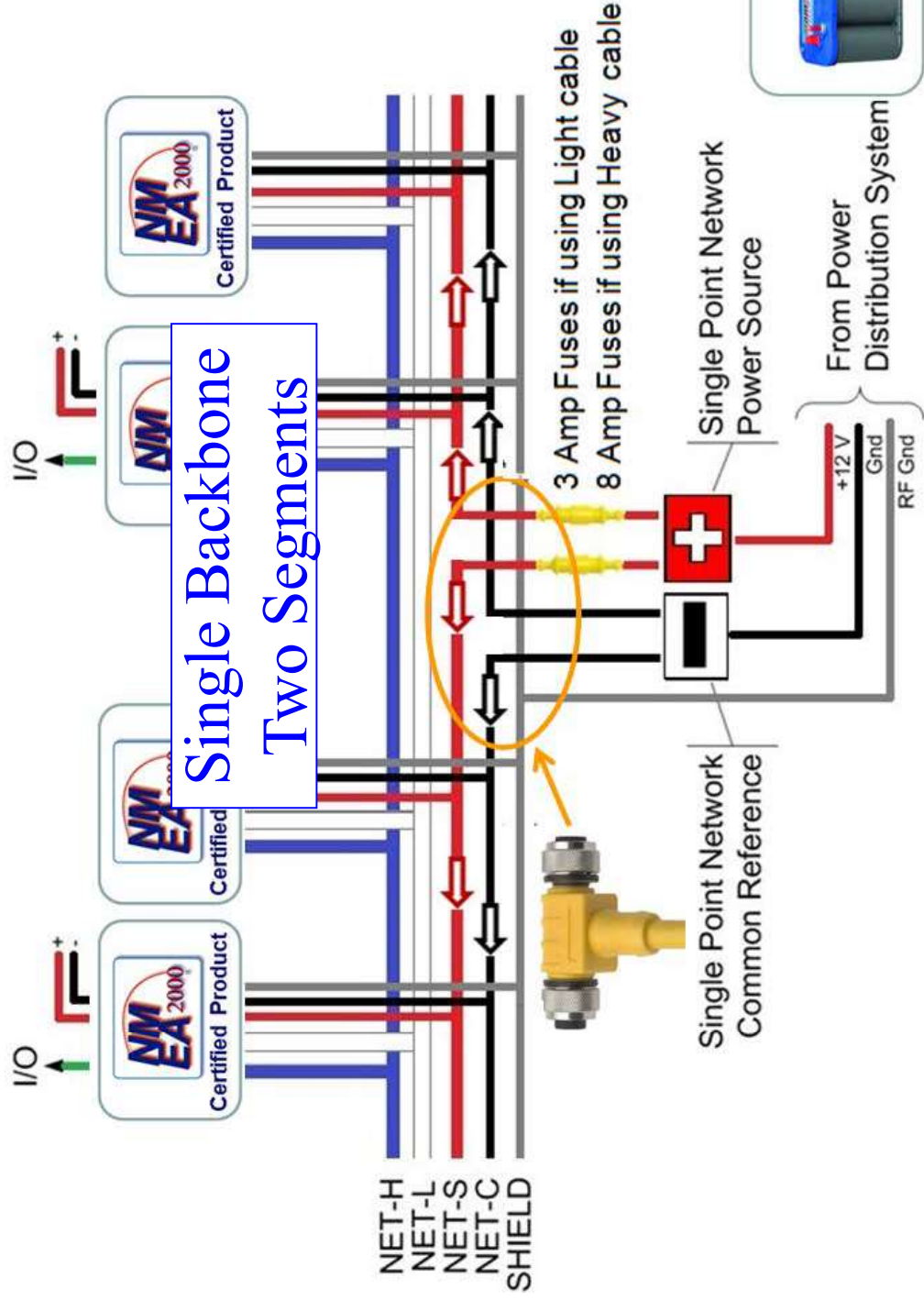

Power Sources

- Battery (nominally 12.0 VDC)
 - Allowed voltage drop = 1.5 VDC
- Typical power supply (13.8 VDC)
 - Allowed voltage drop = 3.0 VDC
- Maximum power supply (15 VDC)
 - Maximum allowed voltage drop = 5.0 VDC

Other Considerations

- Products may be added to or removed from the backbone while operational
- No daisy-chaining ensures backbone remains intact when removing equipment
- Two terminators required, one at each end of the backbone

Making the Right Selections

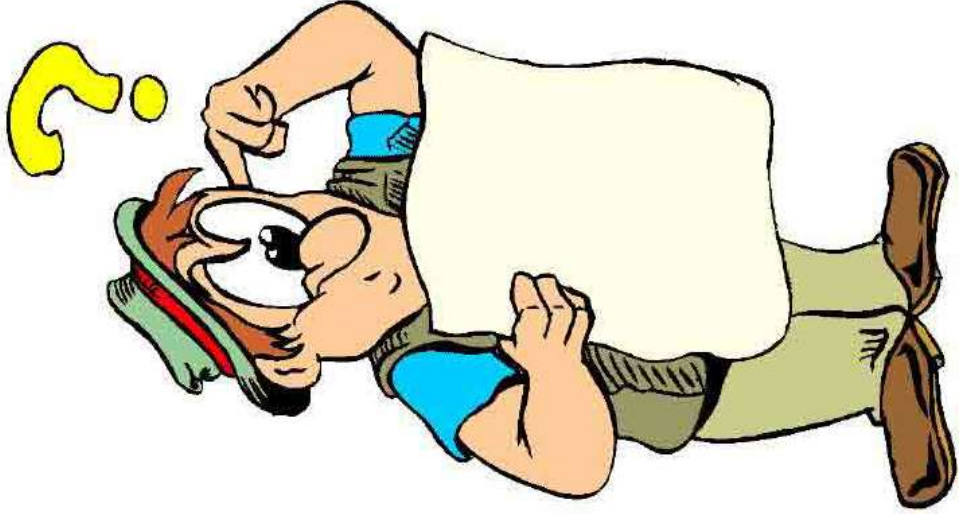

Network Design Drivers

- Network power distribution
 - Segment voltage drop limit
 - Add power insertion points as needed
- Network topology
 - Keep it pure

Network Voltage Drop

- Straightforward application of Ohm's Law

$$E = I \times R$$

where

E = voltage drop

I = circuit current

R = wire resistance

Network Voltage Drop

- Wire resistance

$$R = 2 \times \text{Length} \times \text{Power Pair Resistance} / 100$$

- Network current

$$I = \text{LEN} \times 0.050 \text{ amp}$$

- All together

$$E = 0.1 \times \text{LEN} \times L \times 0.057 \text{ (Light)}$$

$$E = 0.1 \times \text{LEN} \times L \times 0.016 \text{ (Mid/ Heavy)}$$

Estimated Length - Light

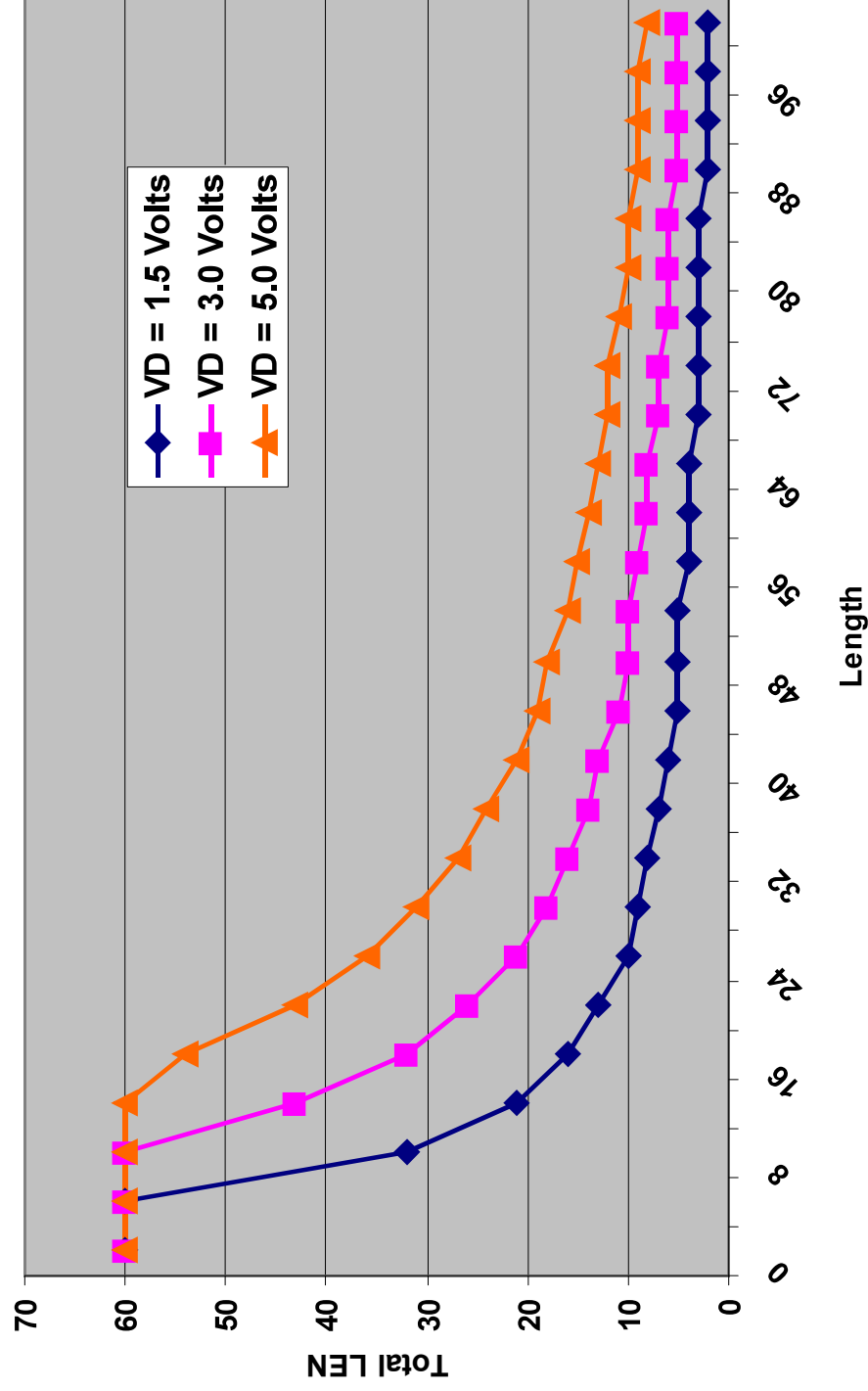

Example Network

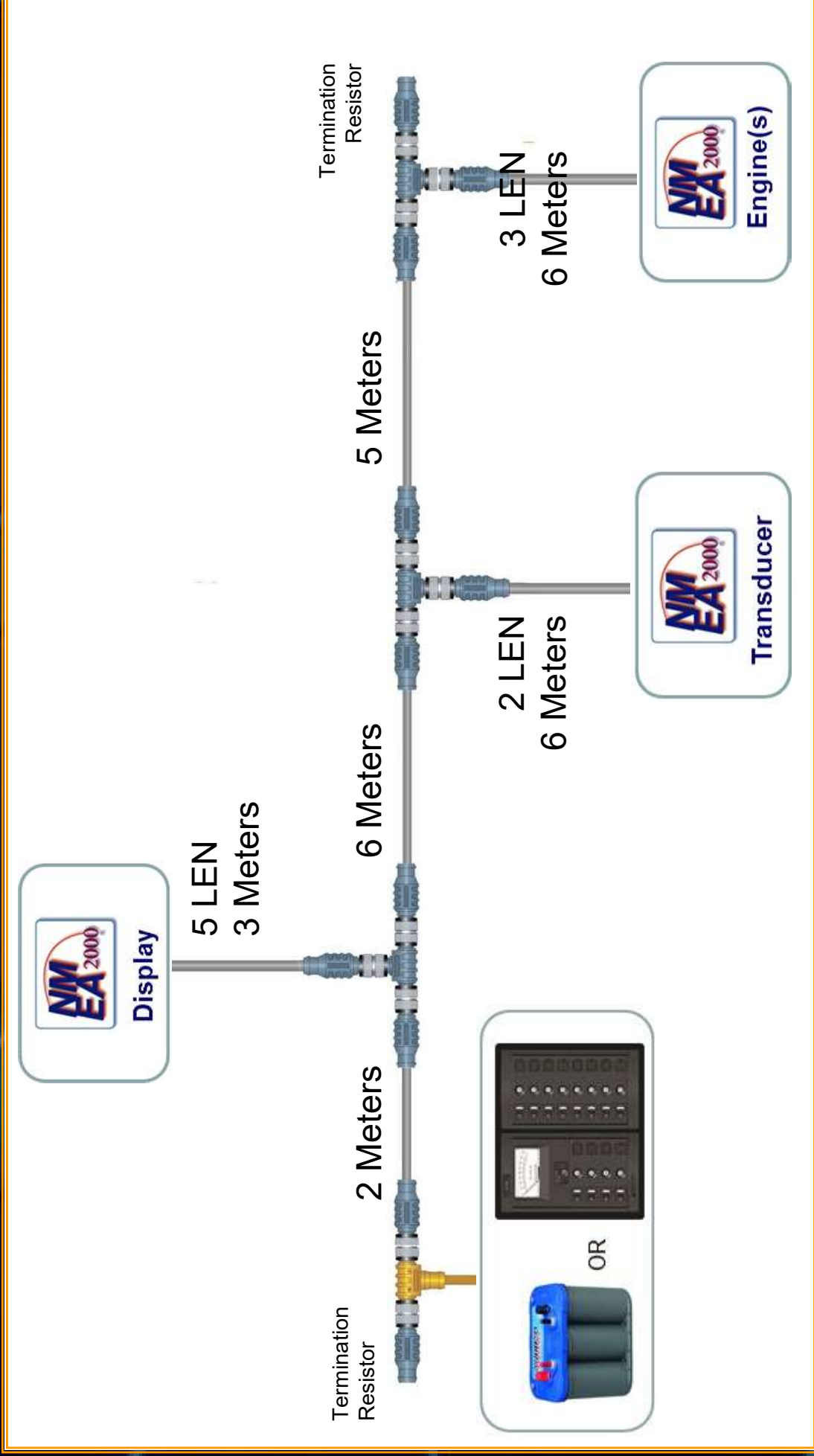

Example Summary

- Total load = 10 LEN
- Backbone length = 13 meters
- Using light cable
 - Power pair resistance = 0.057 Ω /meter

$$E = 0.1 \times 10 \times 13 \times 0.057$$

$$E = 0.74 \text{ Volts}$$

Estimated Length - Light

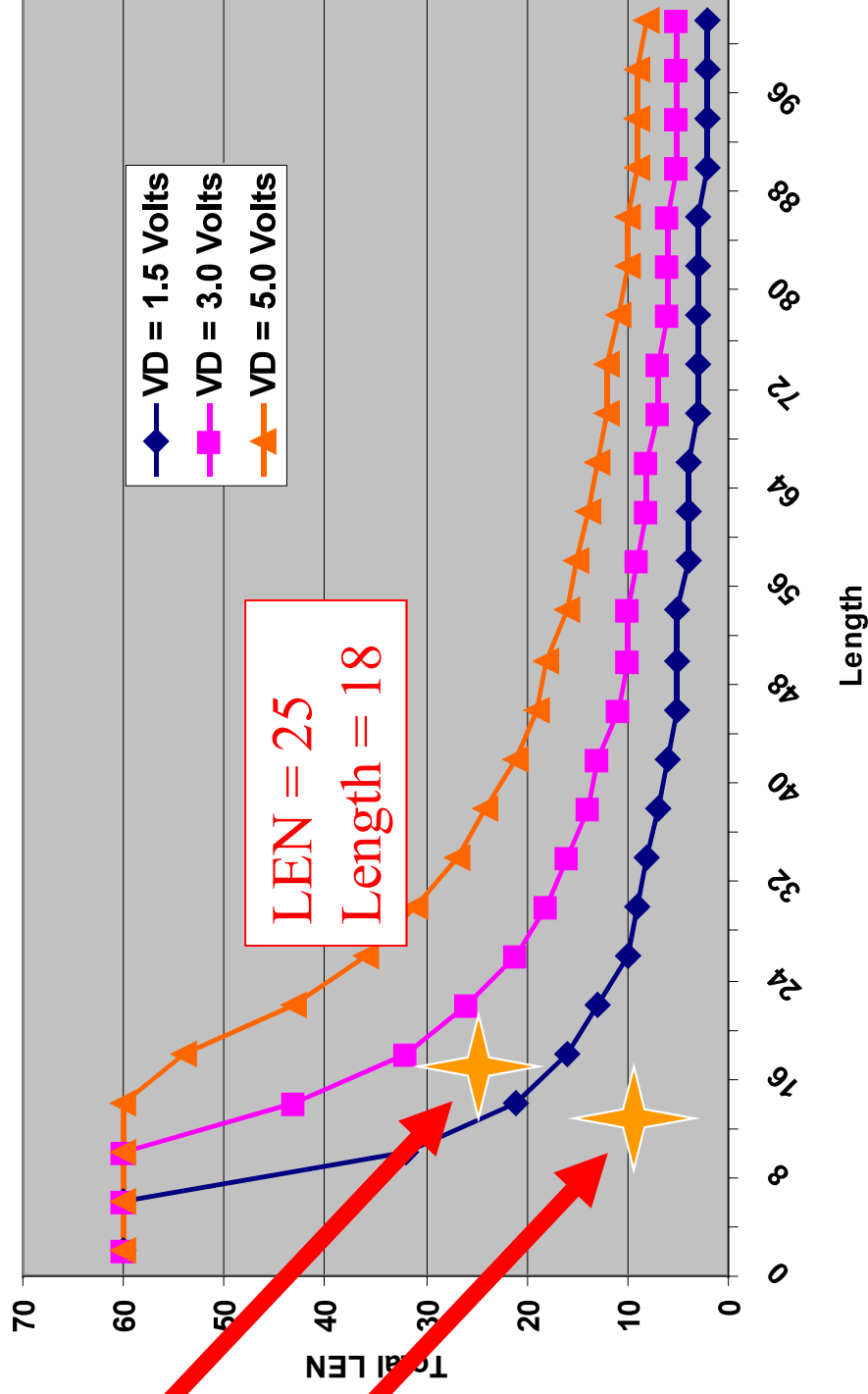

Network Layout

- ‘Trunk and Drop’ Topology
- Determine location for each product
- Determine path for trunk/backbone that:
 - Passes within 6 meters of each product
 - Total of all drops < 78 meters
- Determine number and location of power insertion points

Network Layout

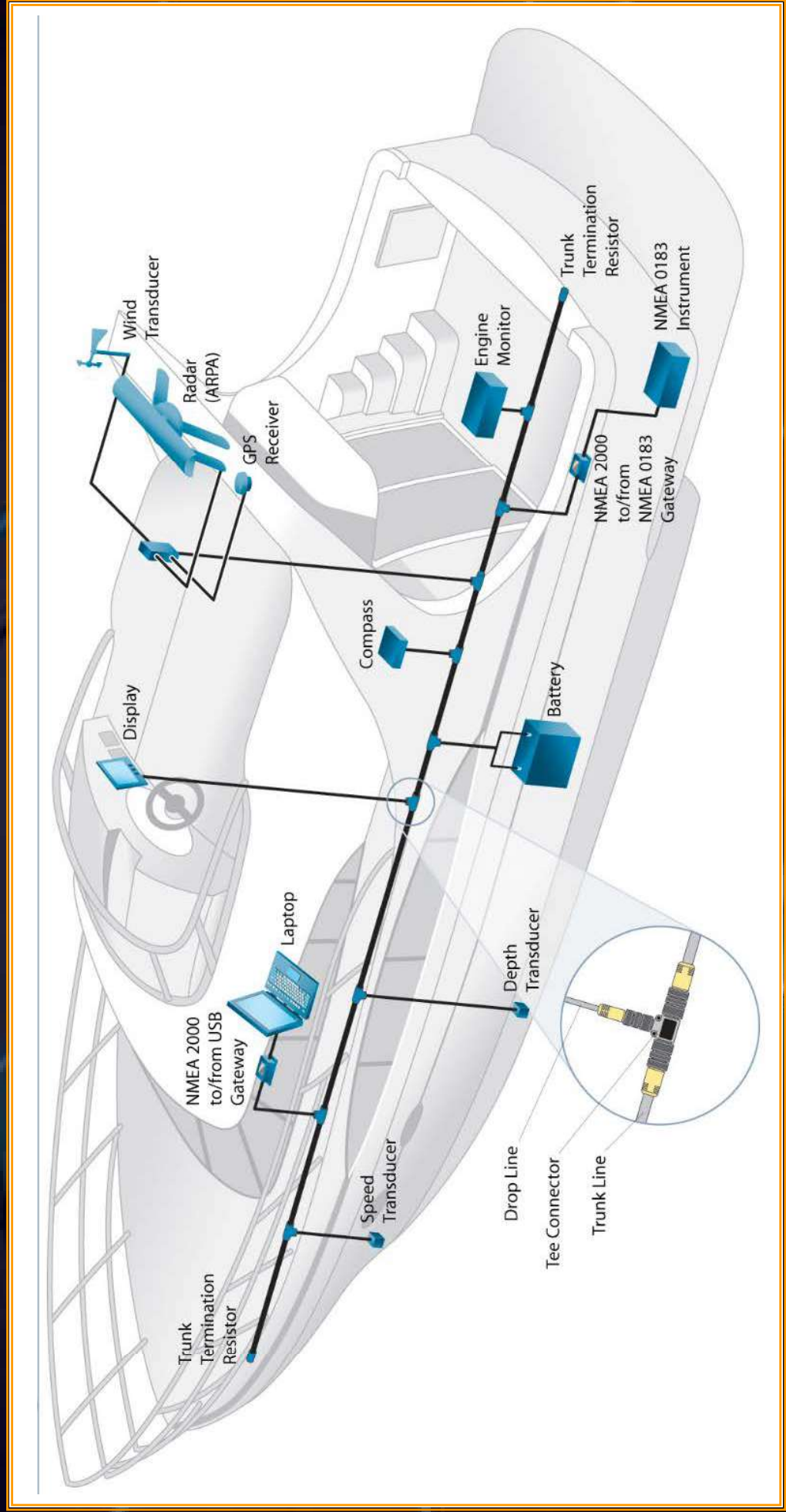

Layout Issues

- Multiple connections in confined spaces
- Sailboat masts & powerboat towers
- Gateways to other protocols
- Multiple backbone configurations

Multiple Connections in Confined Spaces



- Multi-tap tee is used just like multiple tees
- Multi-drop splitter has some limitations

Multi-tap Drop

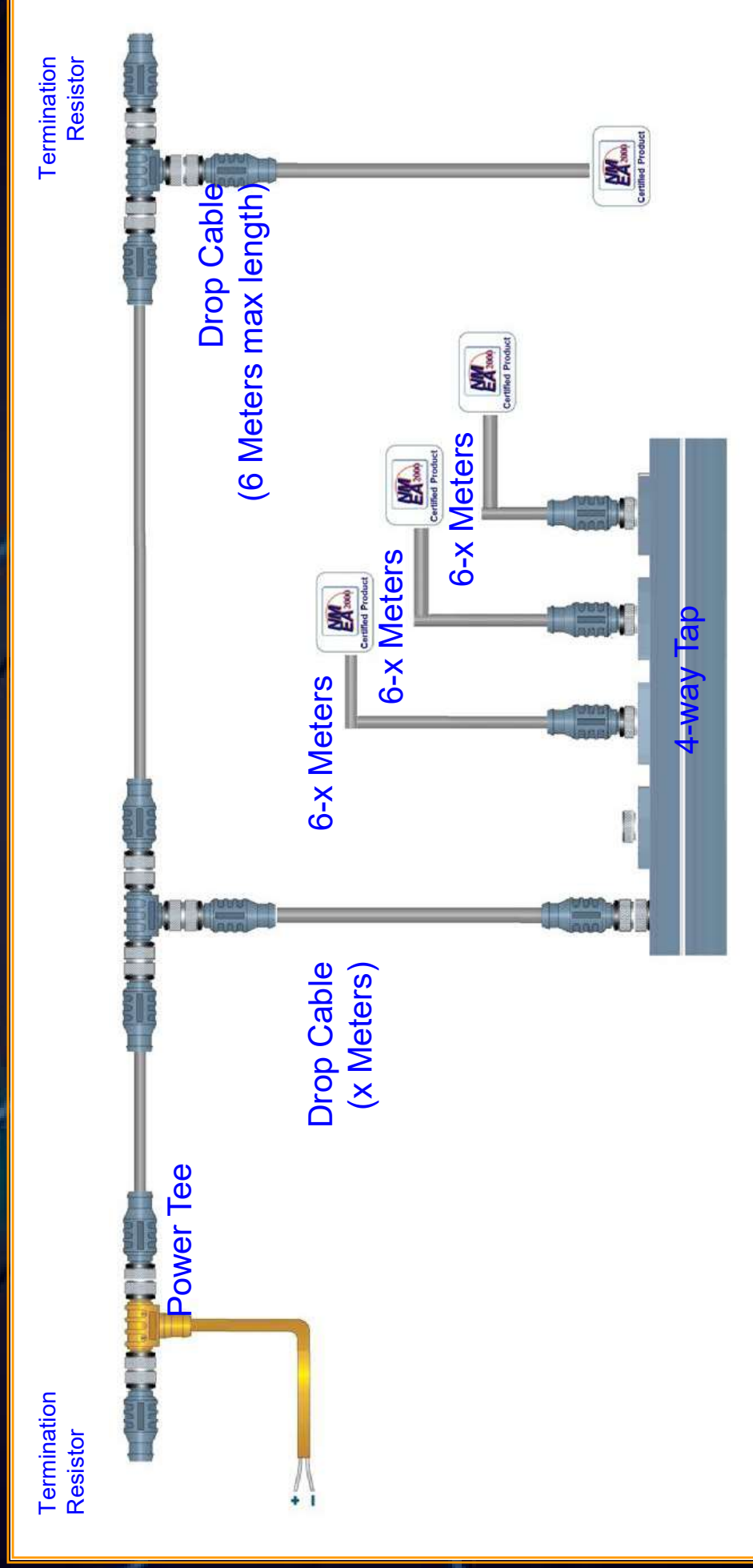

Max length of each drop must be reduced by the length of the drop cable between the Tee and the multi-tap

Sailboat Masts

- Most masts are greater than 6 Meters
- Backbone termination at the top of the mast
- In-Line termination resistors are used
- Must be within 6 meters of last device
- Some manufacturers have a built-in termination resistors on cables > 6 meters

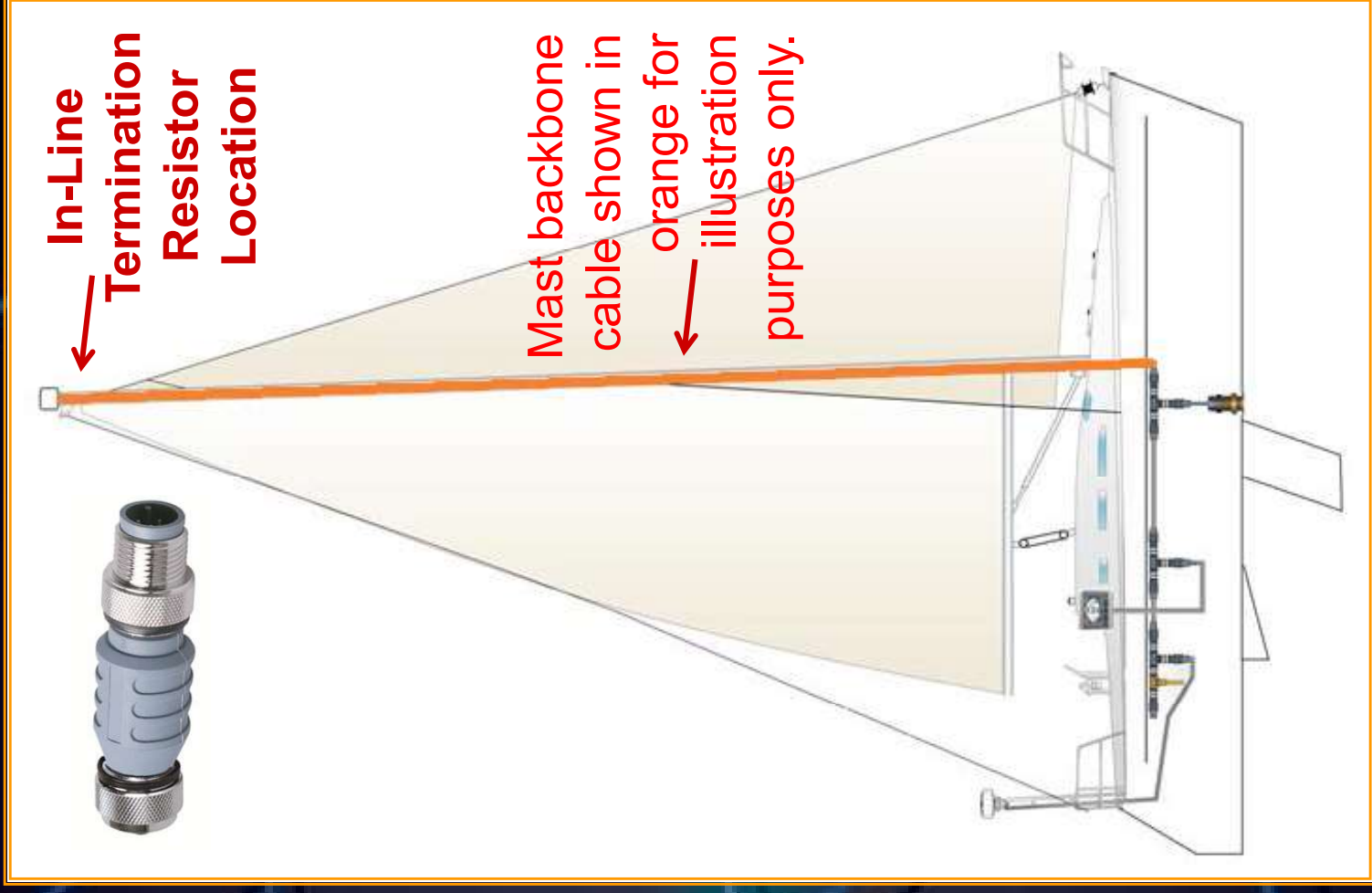

Gateways

NMEA 2000 GPS information is sent to VHF radio for DSC broadcast

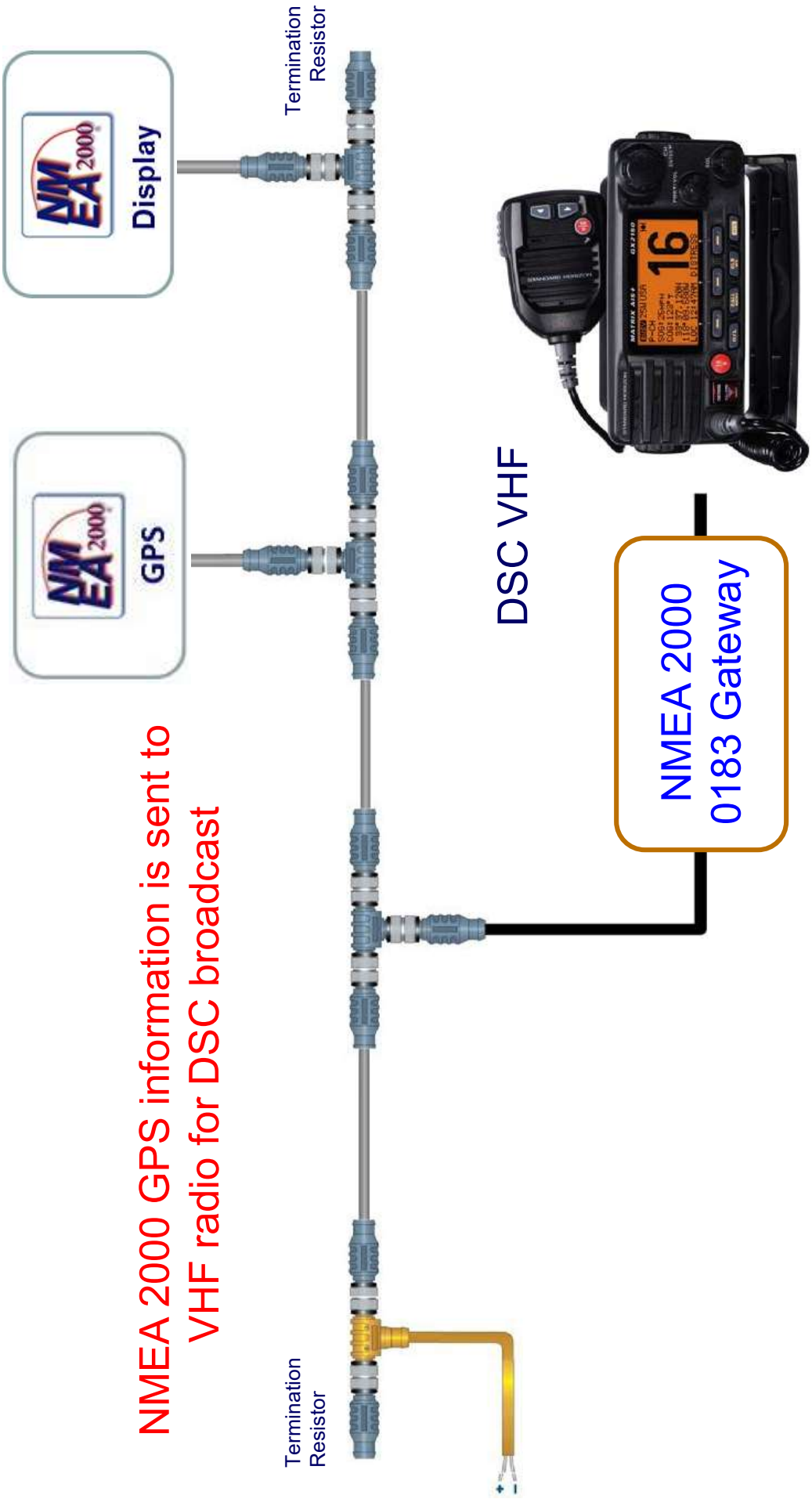

Gateways

J1939 data is converted and transmitted
on the NMEA 2000 Network

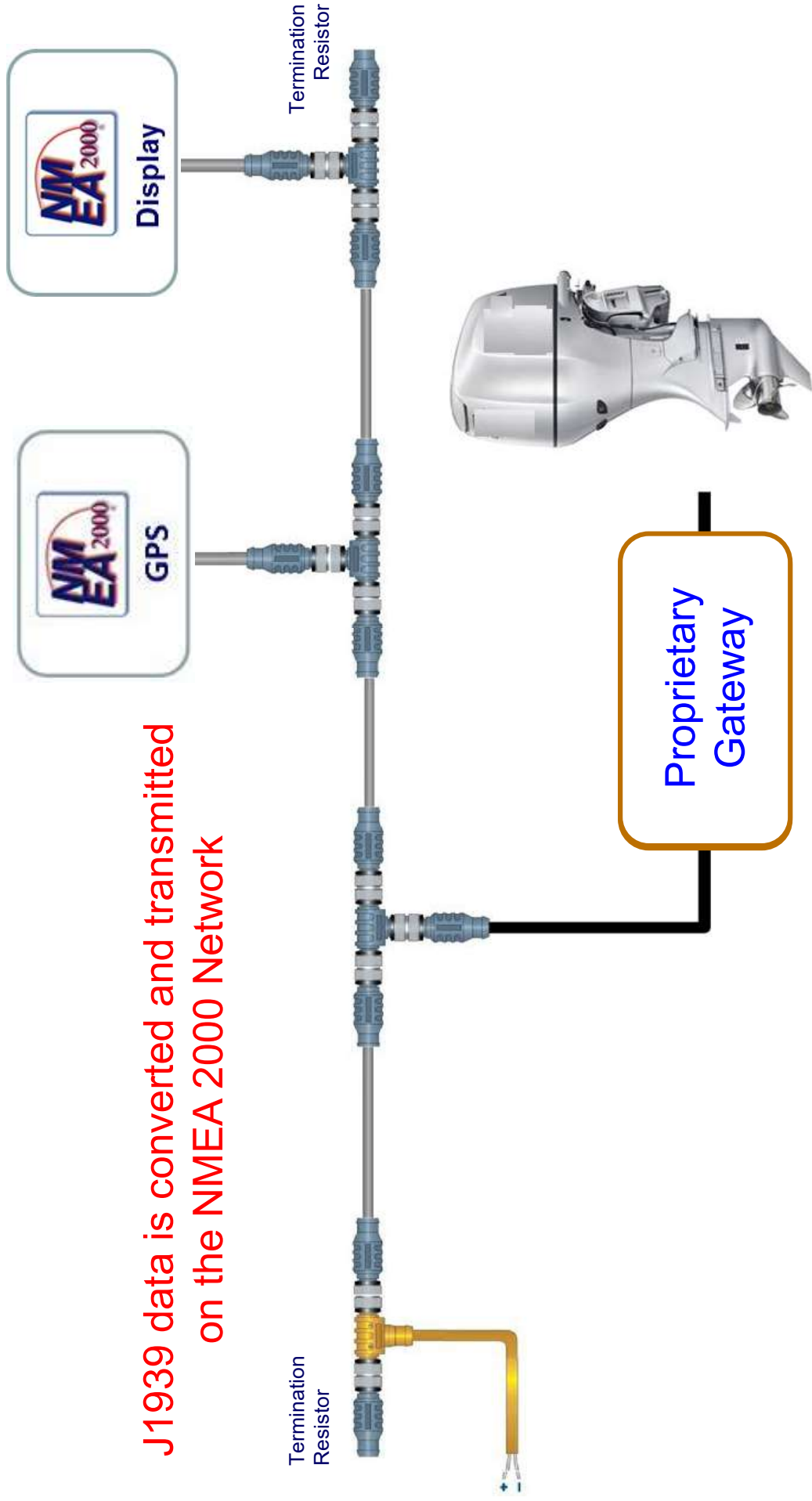

NMEA 2000 Network Bridge

- Connect two networks
- > 50 nodes
- Backbone > 200 meters
- Drops > 78 meters

Useful For:

- Separate mast backbone from main
- Separate critical equipment
- Port/stbd redundancy



Power Insertion

- How many insertion points?
- Common reference point
- Connect shield to RF ground only once
- Each leg has only one power source – consecutive legs not connected
 - Risk of harmonics between power supplies
 - Risk of cumulative voltage drop exceeding common mode offset limits

Power Insertion

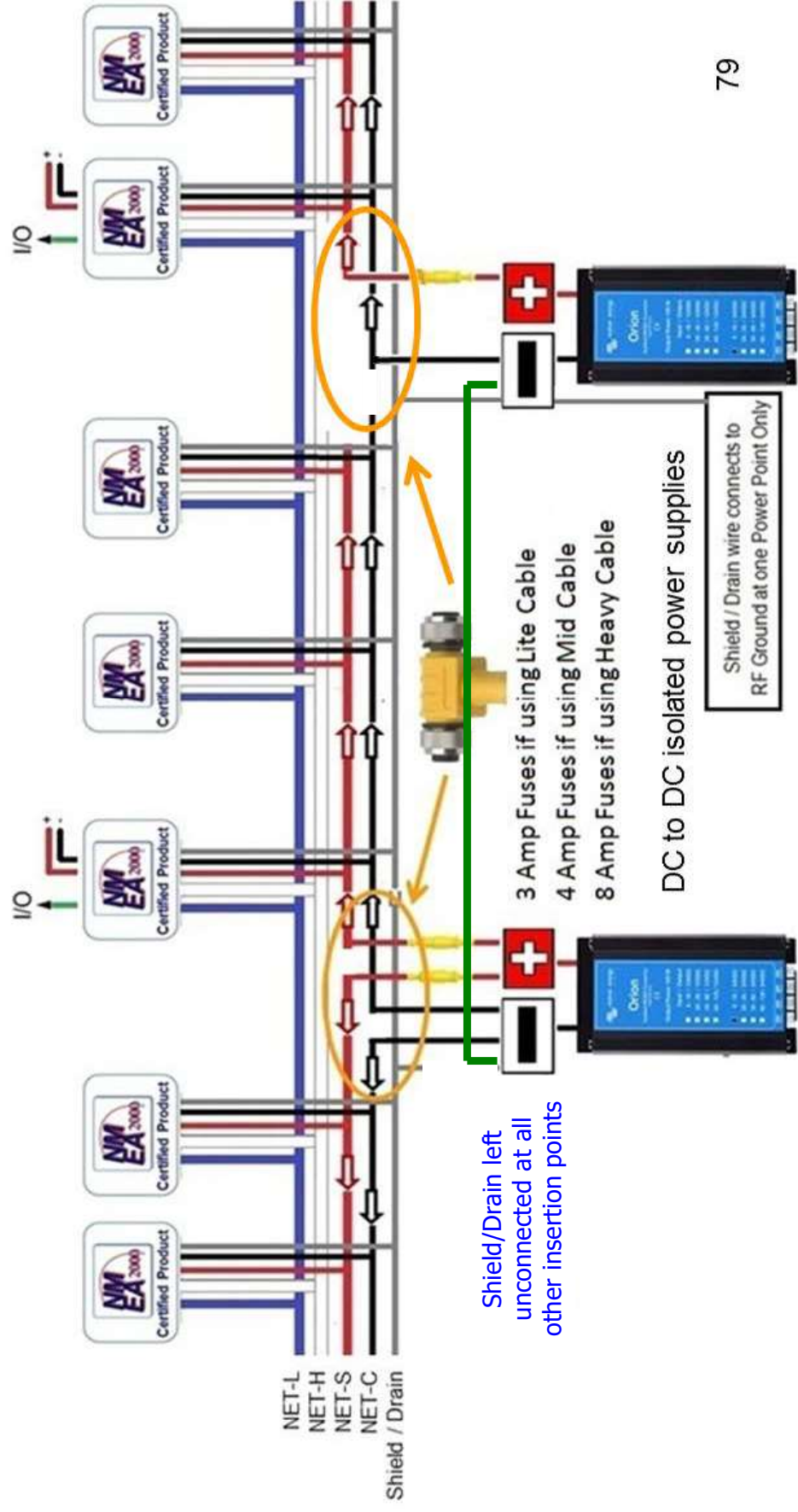

Power Insertion Building Blocks



Testing



Testing Checklist



Loose connections



Voltage fluctuations & data errors

- Voltage consistent and > 9 VDC at all tees







Correct termination

- Approximately 60Ω across data pair when power off



No sustained error rate

Testing Checklist

-  50 connected products or less
-  Drops 6 meters or less
-  Total drops 78 meters or less
-  Network 200 meters or less
-  All power tap leads powered

Plug and Play Limitation

- Layout and power planning rules result in products communicating non-destructively
- Product configuration ensures data displayed is data intended
- Manufacturer configurability may vary
- New Label and Configuration messages will unify methods in use

Acknowledgements and Contact Information

Photos courtesy of Aimar, Actisense, Garmin, LTW,
Maretron, Molex, Turck

Diagrams courtesy NMEA

Contact Information:

David Morschhauser

dave@netsavvy.com

MYSTIC VALLEY COMMUNICATIONS LLC

<http://www.nmea2000solutions.com>