

SPX 10, SPX 30, SPX-SOL

Installation instructions

ENGLISH

Date: 07-2012

Document number: 87072-4-EN

© 2012 Raymarine UK Limited

INNOVATION • QUALITY • TRUST

Raymarine®

Trademark and patents notice

Autohelm, hsb², RayTech Navigator, Sail Pilot, SeaTalk, SeaTalk^{NG}, SeaTalk^{HS} and Sportpilot are registered trademarks of Raymarine UK Limited. RayTalk, Seahawk, Smartpilot, Pathfinder and Raymarine are registered trademarks of Raymarine Holdings Limited.

FLIR is a registered trademark of FLIR Systems, Inc. and/or its subsidiaries.

All other trademarks, trade names, or company names referenced herein are used for identification only and are the property of their respective owners.

This product is protected by patents, design patents, patents pending, or design patents pending.

Fair Use Statement

You may print no more than three copies of this manual for your own use. You may not make any further copies or distribute or use the manual in any other way including without limitation exploiting the manual commercially or giving or selling copies to third parties.

Software updates

Check the website www.raymarine.com for the latest software releases for your product.

Product handbooks

The latest versions of all English and translated handbooks are available to download in PDF format from the website www.raymarine.com.
Please check the website to ensure you have the latest handbooks.

Copyright ©2012 Raymarine UK Ltd. All rights reserved.

ENGLISH

Document number: 87072-4

Date: 07 2012

Contents

Chapter 1 Important information.....	7	4.3 Initial checks for the autopilot installation	29
Safety notices	7	Chapter 5 Maintenance and support	31
General Information	7	5.1 Service and maintenance	32
Chapter 2 Planning the installation	9	5.2 Cleaning	32
2.1 Handbook information	10	5.3 Raymarine customer support.....	32
2.2 Installation checklist	11	Appendix A Technical specification	33
2.3 Inboard autopilot system	11	Appendix B NMEA 0183 sentences	34
2.4 SeaTalk ^{ng} autopilot system	12	Appendix C SeaTalk^{ng} cables and accessories	34
2.5 SeaTalk autopilot system	14	Appendix D SeaTalk accessories.....	35
2.6 Parts supplied	15		
2.7 Required additional components	15		
Chapter 3 Cables and connections.....	17		
3.1 General cabling guidance	18		
3.2 SPX-10 / SPX-30 connections overview	18		
3.3 SPX-SOL connections overview	19		
3.4 Power and drive cables	19		
3.5 Fuses and circuit protection	21		
3.6 Grounding	21		
3.7 SPX to SeaTalk ^{ng} connection	22		
3.8 SeaTalk connection	23		
3.9 NMEA 0183 connection	25		
3.10 Compass connection	25		
3.11 Rudder reference connection	26		
3.12 Sleep switch connection	26		
Chapter 4 Installation	27		
4.1 Location requirements for SPX course computers	28		
4.2 Installing the SPX course computer	28		

Chapter 1: Important information

Safety notices



Warning: Autopilot system Installation

As correct performance of the vessel's steering is critical for safety, we STRONGLY RECOMMEND that an Authorized Raymarine Service Representative fits this product. You will only receive full warranty benefits if you can show that an Authorized Raymarine Service Representative has installed and commissioned this product.



Warning: Product installation and operation

This product must be installed and operated in accordance with the instructions provided. Failure to do so could result in personal injury, damage to your vessel and/or poor product performance.



Warning: Maintain a permanent watch

Always maintain a permanent watch, this will allow you to respond to situations as they develop. Failure to maintain a permanent watch puts yourself, your vessel and others at serious risk of harm.



Warning: Ensure safe navigation

This product is intended only as an aid to navigation and must never be used in preference to sound navigational judgment. Only official government charts and notices to mariners contain all the current information needed for safe navigation, and the captain is responsible for their prudent use. It is the user's responsibility to use official government charts, notices to mariners, caution and proper navigational skill when operating this or any other Raymarine product.



Warning: Potential ignition source

This product is NOT approved for use in hazardous/flammable atmospheres. Do NOT install in a hazardous/flammable atmosphere (such as in an engine room or near fuel tanks).



Warning: Switch off power supply

Ensure the vessel's power supply is switched OFF before starting to install this product. Do NOT connect or disconnect equipment with the power switched on, unless instructed in this document.



Warning: Product grounding

Before applying power to this product, ensure it has been correctly grounded, in accordance with the instructions in this guide.



Warning: Positive ground systems

Do not connect this unit to a system which has positive grounding.

Caution: Power supply protection

When installing this product ensure the power source is adequately protected by means of a suitably-rated fuse or automatic circuit breaker.

Caution: Service and maintenance

This product contains no user serviceable components. Please refer all maintenance and repair to authorized Raymarine dealers. Unauthorized repair may affect your warranty.

General Information

EMC installation guidelines

Raymarine equipment and accessories conform to the appropriate Electromagnetic Compatibility (EMC) regulations, to minimize electromagnetic interference between equipment and minimize the effect such interference could have on the performance of your system

Correct installation is required to ensure that EMC performance is not compromised.

For **optimum** EMC performance we recommend that wherever possible:

- Raymarine equipment and cables connected to it are:
 - At least 1 m (3 ft) from any equipment transmitting or cables carrying radio signals e.g. VHF radios,

cables and antennas. In the case of SSB radios, the distance should be increased to 7 ft (2 m).



- More than 2 m (7 ft) from the path of a radar beam. A radar beam can normally be assumed to spread 20 degrees above and below the radiating element.
- The product is supplied from a separate battery from that used for engine start. This is important to prevent erratic behavior and data loss which can occur if the engine start does not have a separate battery.
- Raymarine specified cables are used.
- Cables are not cut or extended, unless doing so is detailed in the installation manual.

Note: Where constraints on the installation prevent any of the above recommendations, always ensure the maximum possible separation between different items of electrical equipment, to provide the best conditions for EMC performance throughout the installation

Suppression ferrites

Raymarine cables may be fitted with suppression ferrites. These are important for correct EMC performance. If a ferrite has to be removed for any purpose (e.g. installation or maintenance), it must be replaced in the original position before the product is used.

Use only ferrites of the correct type, supplied by Raymarine authorized dealers.

Declaration of conformity

Raymarine UK Ltd. declares that this product is compliant with the essential requirements of EMC directive 2004/108/EC.

The original Declaration of Conformity certificate may be viewed on the relevant product page at www.raymarine.com.

Product disposal

Dispose of this product in accordance with the WEEE Directive.

■ The Waste Electrical and Electronic Equipment (WEEE) Directive requires the recycling of waste electrical and electronic equipment. Whilst the WEEE Directive does not apply to some Raymarine products, we support its policy and ask you to be aware of how to dispose of this product.

Warranty registration

To register your Raymarine product ownership, please visit www.raymarine.com and register online.

It is important that you register your product to receive full warranty benefits. Your unit package includes a bar code label indicating the serial number of the unit. You will need this serial number when registering your product online. You should retain the label for future reference.

IMO and SOLAS

The equipment described within this document is intended for use on leisure marine boats and workboats not covered by International Maritime Organization (IMO) and Safety of Life at Sea (SOLAS) Carriage Regulations.

Technical accuracy

To the best of our knowledge, the information in this document was correct at the time it was produced. However, Raymarine cannot accept liability for any inaccuracies or omissions it may contain. In addition, our policy of continuous product improvement may change specifications without notice. As a result, Raymarine cannot accept liability for any differences between the product and this document. Please check the Raymarine website (www.raymarine.com) to ensure you have the most up-to-date version(s) of the documentation for your product.

Chapter 2: Planning the installation

Chapter contents

- [2.1 Handbook information on page 10](#)
- [2.2 Installation checklist on page 11](#)
- [2.3 Inboard autopilot system on page 11](#)
- [2.4 SeaTalk^{ng} autopilot system on page 12](#)
- [2.5 SeaTalk autopilot system on page 14](#)
- [2.6 Parts supplied on page 15](#)
- [2.7 Required additional components on page 15](#)

2.1 Handbook information

This handbook describes installation of SPX course computers as part of a SmartPilot autopilot system.

This handbook includes information to help you:

- plan your autopilot system and ensure you have all the necessary equipment,
- install and connect the SPX course computer within the autopilot system,
- obtain support if required.

The handbook is for use with the following products:

- SPX-10, SmartPilot course computer
- SPX-30, SmartPilot course computer
- SPX-SOL, SmartPilot course computer

This and other Raymarine product documentation is available to download in PDF format from www.raymarine.com.

SPX handbooks

SPX documentation

Description	Part number
SPX-10, SPX-30, SPX-SOL Installation instructions Plan and install a SmartPilot system including an SPX course computer.	87072
SPX-40 Installation instructions Plan and install a SmartPilot system including an SPX-40 course computer.	87129
SPX-CAN Installation instructions Plan and install a SmartPilot system including an SPX-CAN course computer.	87073
SPX-DIO Installation instructions Plan and install a SmartPilot system including an SPX-DIO course computer.	87124

p70 / p70R Handbooks

Description	Part number
p70 / p70R Installation and commissioning instructions	87132
p70 / p70R Quick reference guide	86142
p70 / p70R User reference handbook	81331

ST70 Pilot Controller handbooks

Description	Part number
ST70 Pilot Controller — Installation Mounting and connection of the ST70 Pilot controller as part of the SmartPilot system.	87071
ST70 Pilot Controller — Commissioning for SPX autopilot systems Commissioning instructions plus maintenance and troubleshooting information for an SPX SmartPilot system with an ST70 control head.	81287
ST70 Pilot Controller — User reference General operation, setup and user preferences for the SmartPilot system with an ST70 control head.	81288
ST70 Pilot Controller — Quick reference A short guide to general operation of a SmartPilot system with an ST70 control head.	81289

ST70+ handbooks

Description	Part number
ST70+ — Installation Mounting and connection of the ST70+ system.	87099
ST70+ Operating guide A short guide to general operation of the ST70+.	81309
ST70+ — User reference System commissioning, general operation, setup, maintenance and troubleshooting.	85024

SeaTalk^{ng} handbooks

Description	Part number
SeaTalk^{ng} reference manual Planning and connection of systems based around the SeaTalk ^{ng} network.	81300
SeaTalk — SeaTalk^{ng} converter handbook Installation and connection of the SeaTalk - SeaTalk ^{ng} converter.	87121

2.2 Installation checklist

Installation includes the following activities:

Installation Task	
1	Plan your system.
2	Obtain all required equipment and tools.
3	Site all equipment.
4	Route all cables.
5	Drill cable and mounting holes.
6	Make all connections into equipment.
7	Secure all equipment in place.
8	Power on and test the system.

Schematic diagram

A schematic diagram is an essential part of planning any installation. It is also useful for any future additions or maintenance of the system. The diagram should include:

- Location of all components.
- Connectors, cable types, routes and lengths.

2.3 Inboard autopilot system

A typical inboard autopilot will consist of the items shown:

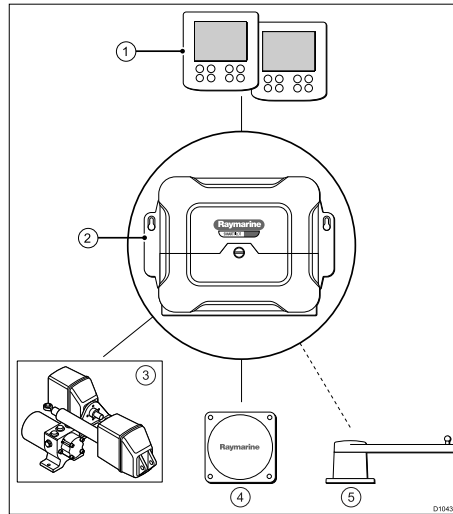

1. **Autopilot control head** — This provides the display and controls required to use the autopilot. Multiple controllers can be added if required, for example a controller at each helm position.
2. **Course computer** — This is the central intelligence hub of the autopilot system, linking the control head to the drive unit.
3. **Drive unit** — The drive unit interfaces with your boat's steering system.
4. **Fluxgate compass**— The fluxgate compass provides the autopilot with a magnetic heading required for maintaining a course.
5. **Rudder reference** — Required for some systems only. This provides feedback from the rudder and can enhance steering performance.

Note: Hydraulic drive units should always use a rudder reference transducer. If in any doubt please contact Raymarine customer support.

In addition the autopilot may receive data from other components, for example:

- **Multifunction display** — The autopilot can connect to a compatible multifunction display. This provides enhanced capabilities for creating and following routes.
- **GPS** — Usually received from a multifunction display, the autopilot uses position data when following routes and calculating the optimum course to steer.
- **Wind transducer** — The autopilot can steer relative to a specified wind angle.

2.4 SeaTalk^{ng} autopilot system

The autopilot may be connected as part of a wider network of marine electronics using SeaTalk^{ng}.

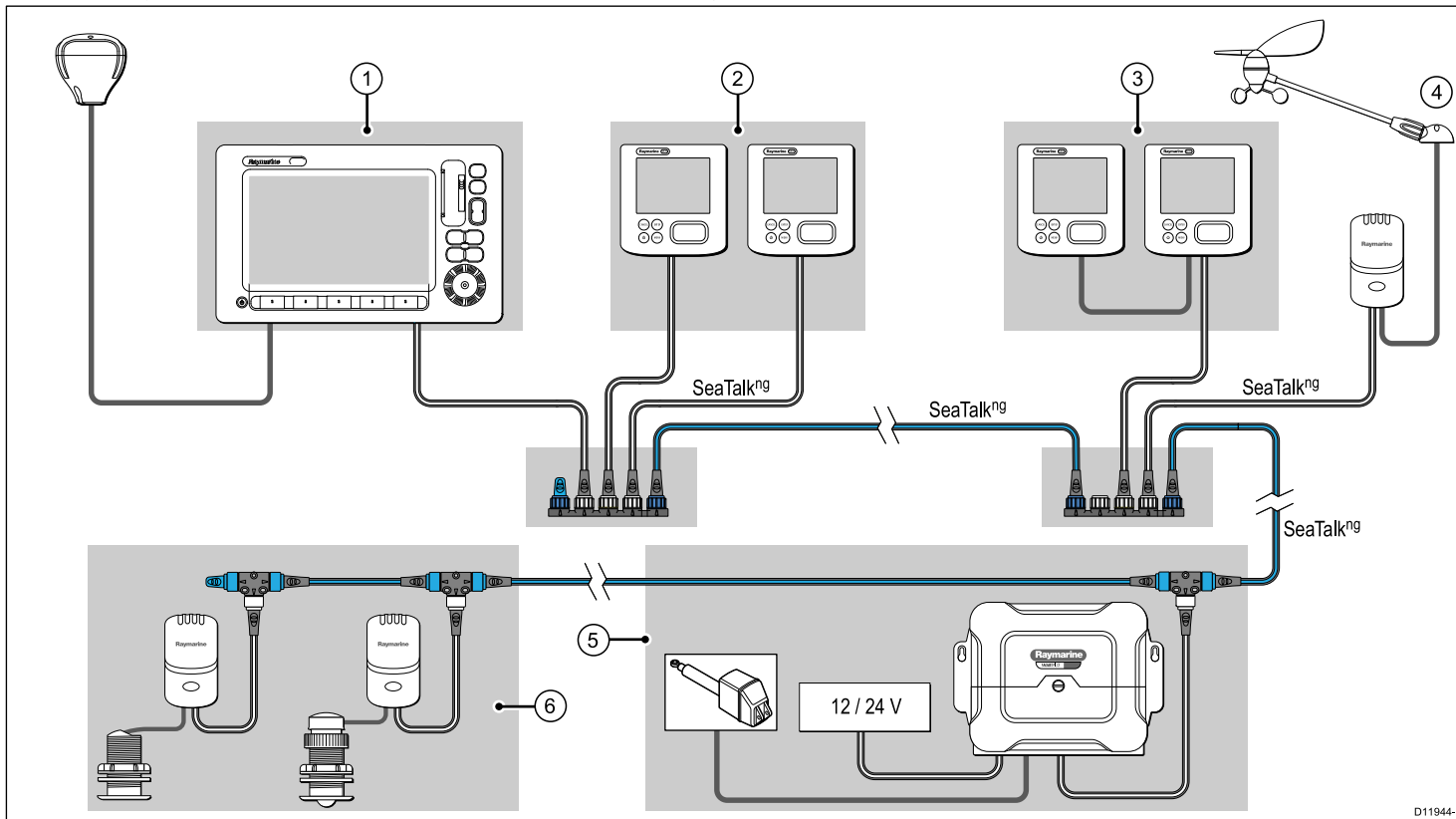

D11944-1

1. Multifunction display with GPS. (GPS may be internal or external)
2. Autopilot controller and instruments (e.g. helm 1)
3. Autopilot controller and instruments (e.g. helm 2)

4. Wind transducer
5. Autopilot course computer and drive unit. This may also supply power to the SPX backbone.
6. Speed / Depth transducers.

Note: The multifunction display will require its own power connection. It cannot take its power from the SeaTalk^{ng} backbone.

Seataalk^{ng}

SeaTalk^{ng} (Next Generation) is an enhanced protocol for connection of compatible marine instruments and equipment. It replaces the older SeaTalk and SeaTalk² protocols.

SeaTalk^{ng} utilizes a single backbone to which compatible instruments connect using a spur. Data and power are carried within the backbone. Devices that have a low draw can be powered from the network, although high current equipment will need to have a separate power connection.

SeaTalk^{ng} is a proprietary extension to NMEA 2000 and the proven CAN bus technology. Compatible NMEA 2000 and SeaTalk / SeaTalk² devices can also be connected using the appropriate interfaces or adaptor cables as required.

NMEA 2000

NMEA 2000 offers significant improvements over NMEA 0183, most notably in speed and connectivity. Up to 50 units can simultaneously transmit and receive on a single physical bus at any one time, with each node being physically addressable. The standard was specifically intended to allow for a whole network of marine electronics from any manufacturer to communicate on a common bus via standardized message types and formats.

2.5 SeaTalk autopilot system

The autopilot may be connected as part of a wider network of marine electronics using SeaTalk.

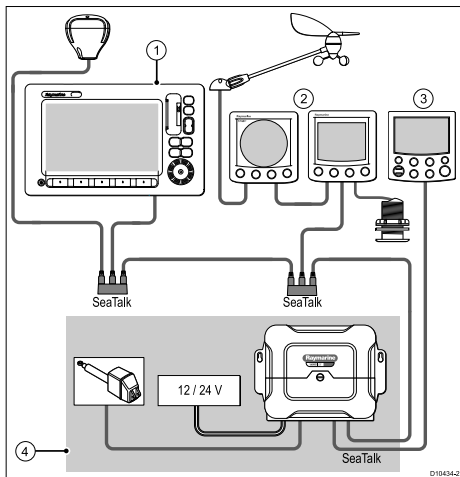

1. Multifunction display with GPS. (GPS may be internal or external.)
2. Wind and depth instruments
3. Autopilot controller
4. Autopilot course computer and drive unit. This may also supply power to SeaTalk instruments and the autopilot controller.

Note: The multifunction display will require its own power connection. It cannot take its power from SeaTalk.

SeaTalk

SeaTalk is a protocol which enables compatible instruments to connect to each other and share data.

The SeaTalk cable system is used to connect compatible instruments and equipment. The cable carries power and data and enables connection without the need for a central processor.

Additional instruments and functions can be added to a SeaTalk system, simply by plugging them into the network. SeaTalk equipment can also communicate with other non-SeaTalk equipment via the NMEA 0183 standard, provided a suitable interface is used.

NMEA 0183

The NMEA 0183 Data Interface Standard was developed by the National Marine Electronics Association of America. It is an international standard to enable equipment from many different manufacturers to be connected together and share information.

The NMEA 0183 standard carries similar information to SeaTalk. However it has the important difference that one cable will only carry information in one direction. For this reason NMEA 0183 is generally used to connect a data receiver and a transmitter together, e.g. a compass sensor transmitting heading to a radar display. This information is passed in 'sentences', each of which has a three letter sentence identifier. It is therefore important when checking compatibility between items that the same sentence identifiers are used some examples of which are:

- VTG - carries Course and Speed Over Ground data.
- GLL - carries latitude and longitude.
- DBT - carries water depth.
- MWV - carries relative wind angle and wind speed data.

NMEA baud rates

The NMEA 0183 standard operates at a number of different speeds, depending upon the particular requirement or equipment capabilities. Typical examples are:

- 4800 baud rate. Used for general purpose communications, including FastHeading data.

- 9600 baud rate. Used for Navtex.
- 38400 baud rate. Used for AIS and other high speed applications.

2.6 Parts supplied

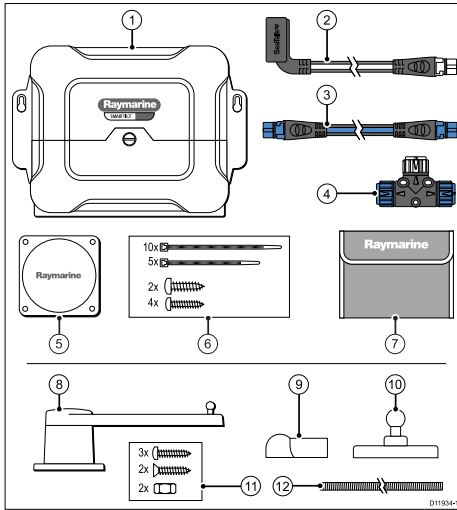

1. SPX course computer
2. 1 m (3.3 ft) SPX - SeaTalk^{ng} spur cable
3. 400 mm (15 in) SeaTalk^{ng} backbone cable
4. SeaTalk^{ng} T-piece
5. Fluxgate compass
6. Course computer mounting screws and cable ties
7. Documentation pack
8. Rudder reference (Not supplied with SPX-10)
9. Ball joint cap (Not supplied with SPX-10)
10. Ball joint (Not supplied with SPX-10)
11. Rudder reference mounting screws (Not supplied with SPX-10)
12. M6 threaded bar (Not supplied with SPX-10)

2.7 Required additional components

To complete your autopilot system, you will need the following components in addition to the SPX core pack.

- Compatible autopilot controller.
- Drive unit appropriate for your boat and autopilot course computer.
- Power and drive cables.

Autopilot controllers

There are a number of autopilot controllers available for connection to your system.

The autopilot controller may be connected using either SeaTalk^{ng} or SeaTalk, depending upon the course computer and any existing marine electronics connected.

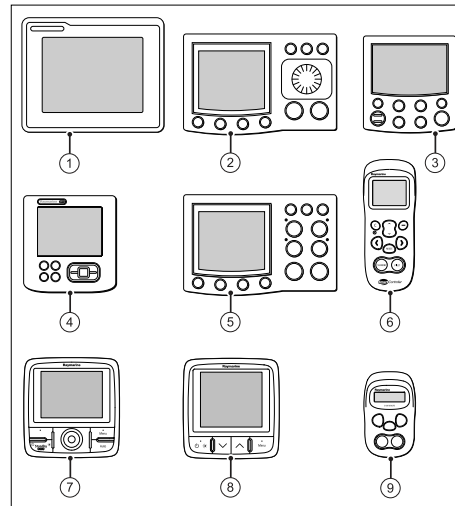

	Pilot controller	SeaTalk ^{ng}	SeaTalk
1	ST70+	•	• (repeat controller only)
2	ST8002		•
3	ST6002		•
4	ST70	•	• (repeat controller only)
5	ST7002		•
6	Smart controller		• (repeat controller only)
7	p70R	•	•
8	p70	•	•
9	S100 remote		• (repeat controller only)

Drive units

The drive unit interfaces with the boat's steering system. The type of drive required depends upon your boat and associated steering system.

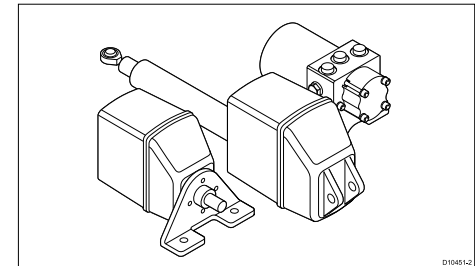

The following are the main categories of drive:

Drive category	Available types	Course computer
Hydraulic pumps	Type 0.5	SPX-10
	Type 1	SPX-10
	Type 2	SPX-30
	Type 3	SPX-30
Hydraulic linear drives	Type 2	SPX-30
	Type 3	SPX-30
Mechanical linear drives used in sailing vessels, the mechanical linear drive moves the rudder directly by pushing the tiller arm or a rudder quadrant.	Type 1	SPX-10
	Type 2	SPX-30
Mechanical rotary drives designed for power and sailboat systems that can be driven from the helm position through a chain and sprocket e.g. cable and rod	Type 1	SPX-10
	Type 2	SPX-30
Universal stern drive		SPX-10
CR Pump (Solenoid)		SPX-SOL

Chapter 3: Cables and connections

Chapter contents

- [3.1 General cabling guidance on page 18](#)
- [3.2 SPX-10 / SPX-30 connections overview on page 18](#)
- [3.3 SPX-SOL connections overview on page 19](#)
- [3.4 Power and drive cables on page 19](#)
- [3.5 Fuses and circuit protection on page 21](#)
- [3.6 Grounding on page 21](#)
- [3.7 SPX to SeaTalk^{ng} connection on page 22](#)
- [3.8 SeaTalk connection on page 23](#)
- [3.9 NMEA 0183 connection on page 25](#)
- [3.10 Compass connection on page 25](#)
- [3.11 Rudder reference connection on page 26](#)
- [3.12 Sleep switch connection on page 26](#)

3.1 General cabling guidance

Cable types and length

It is important to use cables of the appropriate type and length

- Unless otherwise stated use only standard cables of the correct type, supplied by Raymarine.
- Ensure that any non-Raymarine cables are of the correct quality and gauge. For example, longer power cable runs may require larger wire gauges to minimize voltage drop along the run.

Routing cables

Cables must be routed correctly, to maximize performance and prolong cable life.

- Do NOT bend cables excessively. Wherever possible, ensure a minimum bend diameter of 200 mm (8 in) / minimum bend radius of 100 mm (4 in).

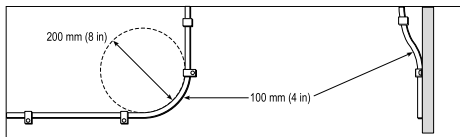

- Protect all cables from physical damage and exposure to heat. Use trunking or conduit where possible. Do NOT run cables through bilges or doorways, or close to moving or hot objects.
- Secure cables in place using tie-wraps or lacing twine. Coil any extra cable and tie it out of the way.
- Where a cable passes through an exposed bulkhead or deckhead, use a suitable watertight feed-through.
- Do NOT run cables near to engines or fluorescent lights.

Always route data cables as far away as possible from:

- other equipment and cables,
- high current carrying ac and dc power lines,

- antennae.

Strain relief

Ensure adequate strain relief is provided. Protect connectors from strain and ensure they will not pull out under extreme sea conditions.

Circuit isolation

Appropriate circuit isolation is required for installations using both AC and DC current:

- Always use isolating transformers or a separate power-inverter to run PC's, processors, displays and other sensitive electronic instruments or devices.
- Always use an isolating transformer with Weather FAX audio cables.
- Always use an isolated power supply when using a 3rd party audio amplifier.
- Always use an RS232/NMEA converter with optical isolation on the signal lines.
- Always make sure that PC's or other sensitive electronic devices have a dedicated power circuit.

Cable shielding

Ensure that all data cables are properly shielded that the cable shielding is intact (e.g. hasn't been scraped off by being squeezed through a tight area).

3.2 SPX-10 / SPX-30 connections overview

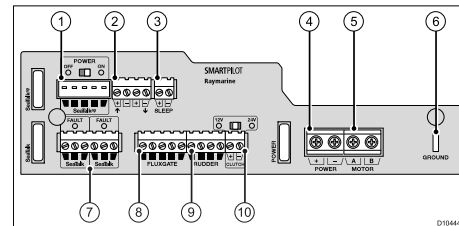

1. SeaTalk^{ng}
2. NMEA 0183 in / out (4800 baud rate)
3. Sleep switch connection
4. Power in
5. Drive power out
6. RF ground
7. SeaTalk
8. Fluxgate compass
9. Rudder position sensor
10. Drive clutch

3.3 SPX-SOL connections overview

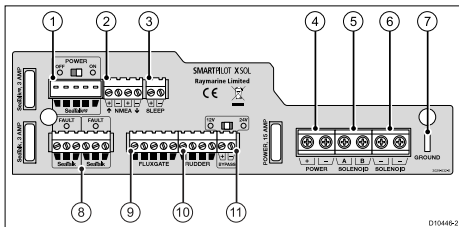

1. SeaTalk^{ng}
2. NMEA 0183 in / out (4800 baud rate)
3. Sleep switch connection
4. Power in
5. Solenoid A and B drive
6. Solenoid A and B return
7. RF ground
8. SeaTalk
9. Fluxgate compass
10. Rudder position sensor
11. Bypass valve

3.4 Power and drive cables

When determining the cable required for the power and drive connections it is necessary to consider the combined cable length of both connections.

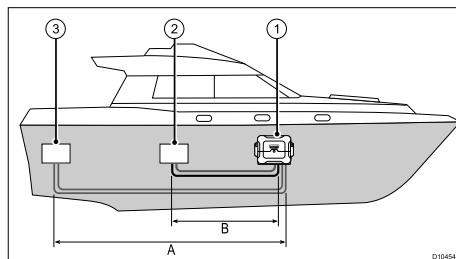

1. Course computer
2. Power supply / distribution panel
3. Drive unit

Power and drive cable selection

Drive	Supply voltage	Max. length (A+B)	Cable size
Type 0.5 hydraulic pump			
<ul style="list-style-type: none"> • Type 1 drive • CR pump (SPX-SOL only) 	12 V	0–7 m (0–23 ft)	2.5 mm ² (14 AWG)
		7–10 m (23–32.8 ft)	4 mm ² (12 AWG)

Drive	Supply voltage	Max. length (A+B)	Cable size
Type 2 drive	12 V	0–5 m (0–16.4 ft)	6 mm ² (10 AWG)
		5–7 m (16.4–23 ft)	10 mm ² (8 AWG)
	24 V	0–3 m (0–9.8 ft)	4 mm ² (12 AWG)
		3–5 m (9.8–16.4 ft)	6 mm ² (10 AWG)
Type 3 drive	12 V	5–10 m (16.4–32.8 ft)	10 mm ² (8 AWG)
		0–5 m (0–16.4 ft)	10 mm ² (8 AWG)
	24 V	0–5 m (0–16.4 ft)	6 mm ² (10 AWG)
		5–7 m (16.4–23 ft)	10 mm ² (8 AWG)

Important: Use of an incorrect power cable size will reduce the power supplied to the drive unit and could cause your autopilot to malfunction. If in doubt, use a heavier gauge cable.

Power and drive connection

Power connection

Power to the course computer must be from an appropriately fused and rated supply.

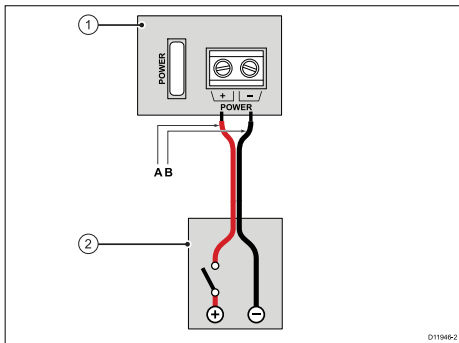

D110460-2

1. Course computer connection panel
2. Power distribution panel

Power connection colors

	Color	Description
A	Red	Power in +ve (12 / 24 V)
B	Black	Power in -ve (0 V)

Drive connection

The drive connects to the connection panel of the course computer.

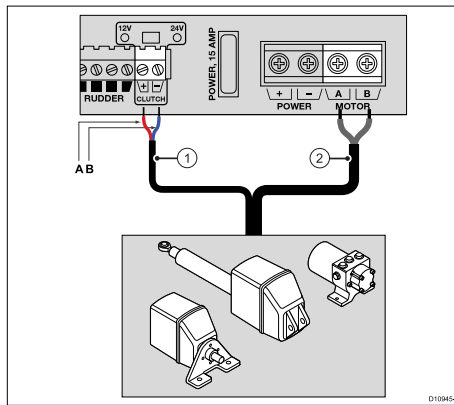

D110461-1

1. Clutch (not all drives have this connection)
2. Motor/drive

Clutch connection colors

	Color	Description
A	Red	Clutch +ve
B	Black	Clutch -ve

Clutch voltage switch

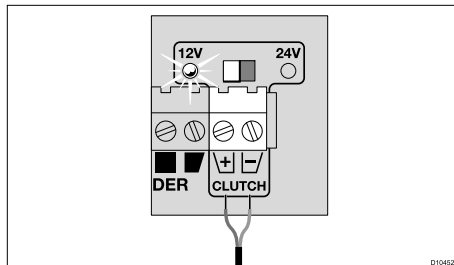

D110462-2

If the drive has a separate clutch connection to the course computer, you must ensure that the clutch voltage switch is set correctly.

Note: The clutch voltage may be different from that of the drive itself, for example the range of both 12 and 24 V Raymarine drives all have a 12 V clutch.

Solenoid drive connection

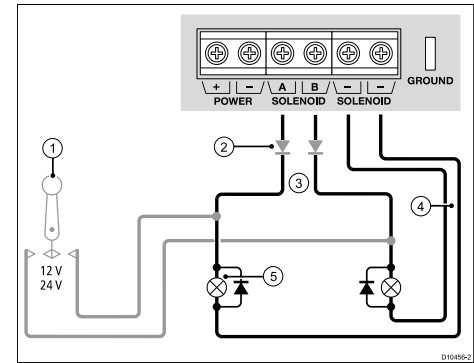

D110465-2

1. Electronic steering / jog lever (if required)
2. Back-feed protection diodes (if using a electronic steering or jog lever)
3. Drive out.
4. Drive return
5. Solenoid valves (with diodes across spool valves)

Care points:

- If an electronic steering or jog lever is used, fit diodes (suggested type: 1N4004) in line with the solenoid outputs to prevent back-feeding the course computer.

3.5 Fuses and circuit protection

Power supply circuit protection

The power supply must be connected using an appropriately rated and fused switch or thermal breaker. The drive type determines the rating of the breaker or fuse required.

Drive unit	Supply voltage	Fuse	Thermal over-current circuit breaker
0.5 I hydraulic pump	12 V	15 A	10 A
Type 1 (Rotary, Linear or Hydraulic)	12 or 24 V	25 A	20 A
Type 2 (Rotary, Linear or Hydraulic)	12 V	40 A	30 A
	24 V	30 A	30 A
Type 3 (Hydraulic linear)	12 V or 24 V	40 A	30 A
I/O	12 V	15 A	10 A
CR pump (Solenoid)	12 or 24 V	10 A	10 A

Internal fuses

The course computer uses standard automotive blade fuses. Spare fuses are located on underside of the removable cover.

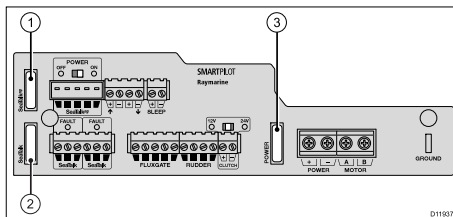

1. SeaTalk^{ng} fuse. (Fuse power supply from course computer to SeaTalk^{ng} backbone).
2. SeaTalk fuse. (Fuse power supply from course computer to connected SeaTalk devices).
3. Power fuse. (Fuse total power consumed by system, including the drive unit.)

	SeaTalk ^{ng}	SeaTalk	Power
SPX-10	2 A	2 A	15 A
SPX-30	3 A	3 A	40 A
SOX-SOL	3 A	3 A	15 A

3.6 Grounding

These grounding requirements are applicable for Raymarine equipment with a dedicated ground terminal.

- The ground terminal must be connected to a common ground point.
- It is recommended that the common ground point is a bonded ground, i.e. with the ground point connected to the battery negative, and situated as close as possible to the battery negative terminal. If a bonded ground system is not possible, a non-bonded RF ground may be used.

Bonded ground system (preferred)

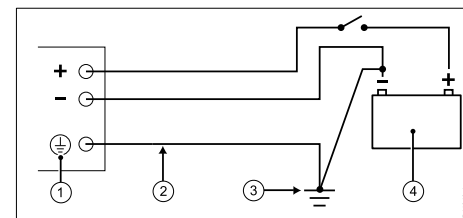

RF ground system (alternative)

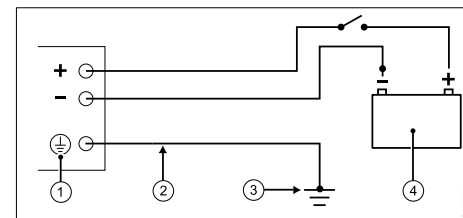

1. Ground terminal. (This may also be labelled as Ground, or Screen.)
2. Ground braid.
3. Bonded (preferred) or non-bonded RF ground.
4. Power supply or battery.

Implementation

If several items require grounding, they may first be connected to a single local point (e.g. within a switch panel), with this point connected via a single, appropriately-rated conductor, to the boat's common ground. The preferred minimum requirement for the path to ground (bonded or non-bonded) is via a flat tinned copper braid, with a 30 A rating (1/4 inch) or greater. If this is not possible, an equivalent stranded wire conductor maybe used, rated as follows:

- for runs of <1 m (3 ft), use 6 mm² (#10 AWG) or greater.
- for runs of >1 m (3 ft), use 8 mm² (#8 AWG) or greater.

In any grounding system, always keep the length of connecting braid or wires as short as possible.

Important: Do NOT connect this product to a positively-grounded power system.

References

- ISO10133/13297
- BMEA code of practice
- NMEA 0400

3.7 SPX to SeaTalk^{ng} connection

The SPX course computer and compatible control heads can be connected using SeaTalk^{ng}.

SeaTalk^{ng} autopilot

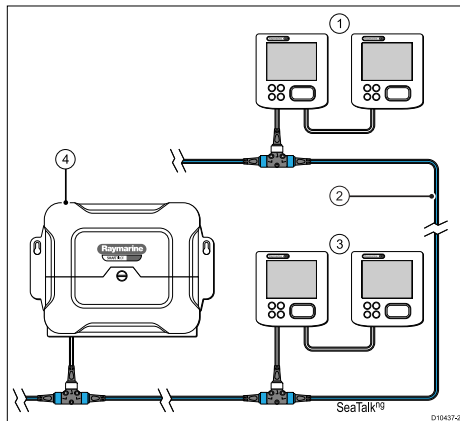

1. Helm position with SeaTalk^{ng} autopilot controller and instrument.
2. SeaTalk^{ng} backbone.
3. Helm position with SeaTalk^{ng} autopilot controller and instrument.
4. SPX course computer.

You can connect an autopilot controller at each helm position.

Note: Only autopilot controllers compatible with SeaTalk^{ng} can be connected to the backbone.

SeaTalk to SeaTalk^{ng} Converter

The SeaTalk to SeaTalk^{ng} converter can be used to connect a SeaTalk autopilot controller to a SeaTalk^{ng} network.

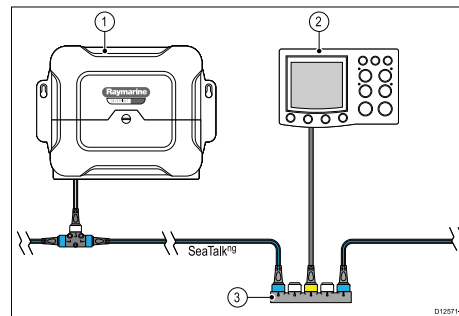

1. SPX course computer.
2. SeaTalk^{ng} autopilot controller.
3. SeaTalk to SeaTalk^{ng} converter.

Note: For correct operation using a SeaTalk to SeaTalk^{ng} converter please ensure that your SPX course computer is upgraded to software version 3.00 or later and the SeaTalk to SeaTalk^{ng} converter to software version 1.14 or later. Please visit the Raymarine website to download the latest software for your products: www.raymarine.com.

SeaTalk^{ng} connection to course computer

The course computer connects to the SeaTalk^{ng} backbone using the spur cable supplied.

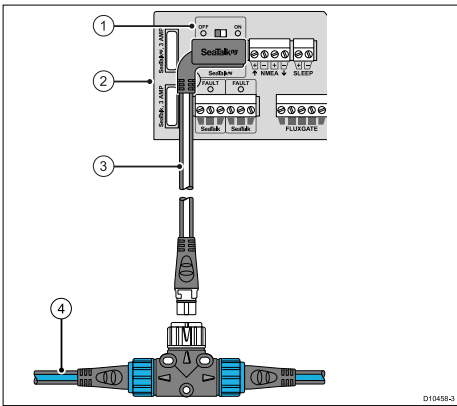

1. SeaTalk^{ng} power switch.
2. Course computer connector panel.
3. SPX to SeaTalk^{ng} spur cable.
4. SeaTalk^{ng} backbone.

Note: The connection at the backbone may be into a T-piece or 5-way connector (not shown).

SeaTalk^{ng} power switch

The course computer can provide power to the SeaTalk^{ng} backbone. This will provide power to certain equipment connected to the backbone (e.g. ST70 pilot controller and instruments).

Set the SeaTalk^{ng} power switch on the connector panel to the appropriate position:

- **ON** — The course computer will supply power to the SeaTalk^{ng} backbone. Ensure that there are no other power feeds connected into the backbone.
- **OFF** — The course computer will not supply power to the SeaTalk^{ng} backbone. Ensure that there is a separate power feed to the SeaTalk^{ng} backbone.

Important: Use correct fuse. The fuse supplying the SeaTalk^{ng} system **MUST** be rated as per the value shown on the connector panel.

3.8 SeaTalk connection

The SPX course computer has 2 SeaTalk connectors available. It is recommended that 1 of these is reserved for connection to the primary autopilot controller.

Example SeaTalk autopilot

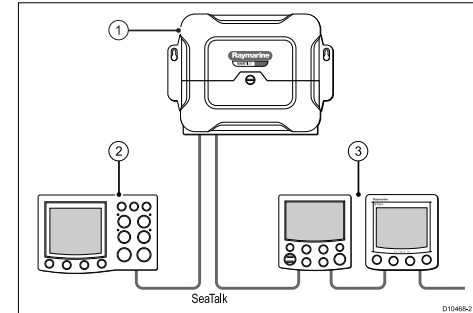

1. SPX course computer.
2. Helm position with primary autopilot controller (on dedicated SeaTalk connection).
3. Helm position with secondary autopilot controller and instrument(s).

SPX to SeaTalk connection

Use a SeaTalk cable. Depending upon the SeaTalk cable obtained, you may need to remove the connector from one end to reveal the cable cores.

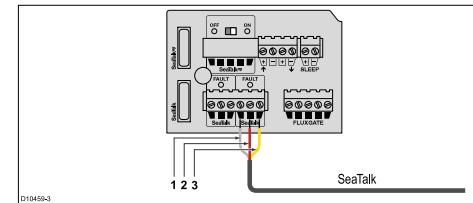

Connection colors

	Color	Description
1	Grey	0 V (-ve)
2	Red	+12 V SeaTalk power out
3	Yellow	SeaTalk data

SeaTalk connection rules

The SeaTalk connections into the course computer depend upon the physical system configuration.

Daisy chain / separate SeaTalk spurs

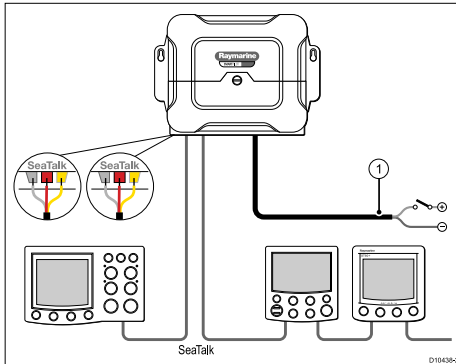

1. Power supply via breaker / fuse.

Care point:

- Connect power (red), data (yellow) and screen (grey) at both sets of SeaTalk terminals.

SeaTalk connected as a ring

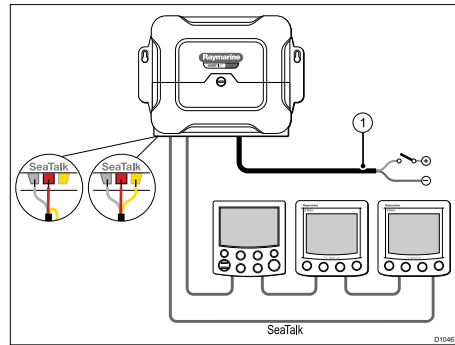

1. Power supply via breaker / fuse.

Care points:

- Connect power (red) and screen (grey) at both sets of terminals.
- Connect data (yellow) at one end only.
- Cut back and insulate unconnected data wire.
- The autopilot controller should be the first device on the ring (working from the course computer data connection).

SeaTalk connected with its own power supply

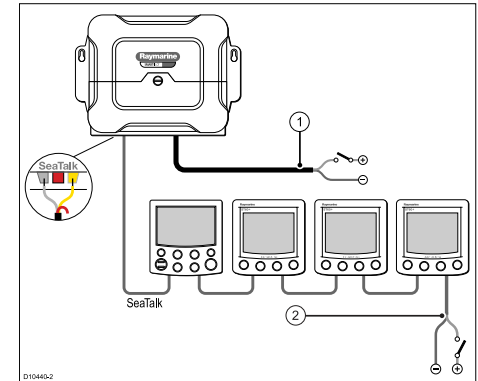

1. Course computer power supply via breaker / fuse.
2. SeaTalk power supply via breaker / fuse rated 5 A or less.

Care points:

- Connect data (yellow) and screen (grey) at SeaTalk terminals.
- Do NOT connect SeaTalk power (red) to the course computer.
- Cut back and insulate unconnected power wire.

Note: Use correct fuse. The fuse supplying the SeaTalk system MUST be rated at 5 A or less.

3.9 NMEA 0183 connection

The SPX autopilot is compatible with NMEA 0183 devices, it provides a 4800 baud rate input/output. Connections are made to the connector panel underneath the removable cover.

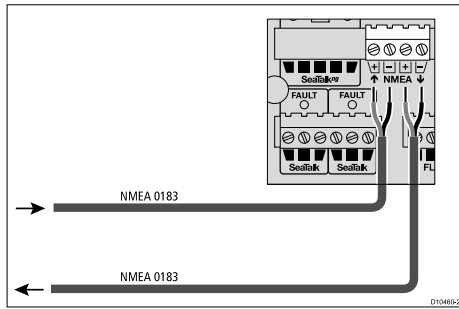

Note: You must not connect more than one piece of equipment to the NMEA 0183 in connection.

FastHeading connection

If you wish to use MARPA (radar target acquisition) functions on a system without an autopilot connected using SeaTalk^{ng} then you will require a dedicated FastHeading connection. The connection uses NMEA 0183 and is made between a compatible Raymarine autopilot (or FastHeading sensor) and the

multifunction display. The FastHeading connection is not required if your autopilot is connected using SeaTalk^{ng}.

Example FastHeading connection

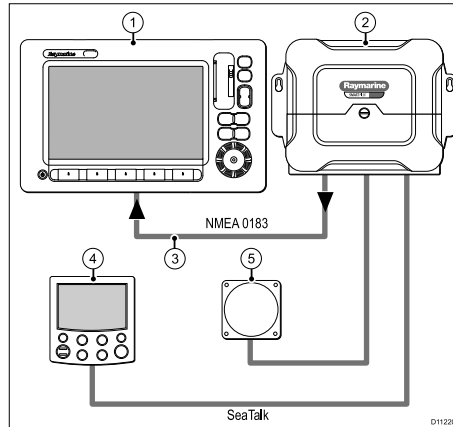

Note: The connection can be made into any NMEA 0183 input at the display.

1. Multifunction display.
2. Autopilot course computer.
3. NMEA 0183 (FastHeading and other relevant data).
4. Autopilot controller.
5. Fluxgate compass.

3.10 Compass connection

The fluxgate compass connects to the course computer connection panel as shown.

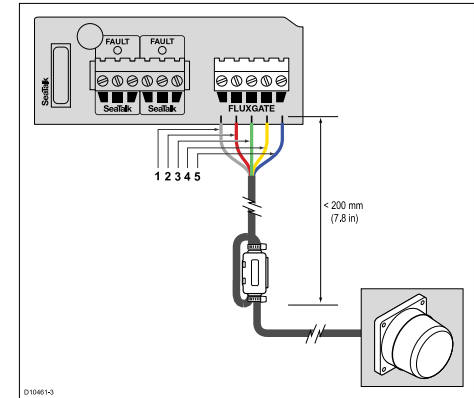

Connection colors

	Color
1	Grey (screen)
2	Red
3	Green
4	Yellow
5	Blue

Cable suppression ferrite

A suppression ferrite is supplied to ensure that the compass is not unduly affected by interference and complies with applicable EMC regulations. This must be fitted to the fluxgate compass cable, ensuring that:

- the compass cable loops twice through the ferrite;
- the ferrite is no more than 200 mm (8 in) from the connection at the course computer, and

- is held in position by cable ties at each end.

3.11 Rudder reference connection

The rudder reference connects to the course computer connection panel as shown.

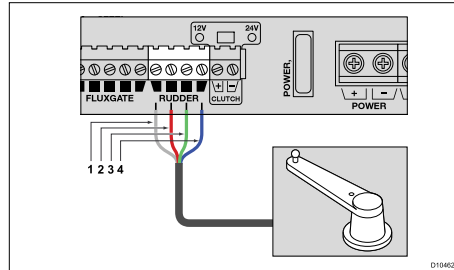

Connection colors

	Color
1	Grey (screen)
2	Red
3	Green
4	Blue

3.12 Sleep switch connection

A Sleep switch disables the operation of the autopilot while retaining any power supplied to the SeaTalk and SeaTalk^{ng} bus.

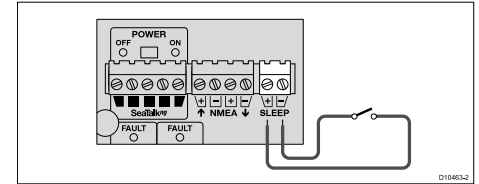

The switch and associated cable are not supplied.

Chapter 4: Installation

Chapter contents

- 4.1 Location requirements for SPX course computers on page 28
- 4.2 Installing the SPX course computer on page 28
- 4.3 Initial checks for the autopilot installation on page 29

4.1 Location requirements for SPX course computers

The installation location must take into account the following requirements:

- Install below decks in a dry area.
- Mount on a vertical surface, the sides and top must be level.
- Location must be at least 1 m (3 ft.) away from any magnetic compass.
- Safe from physical damage and excessive vibration.
- Away from any source of heat.
- Away from any potential flammable hazard, such as fuel vapors.

Dimensions

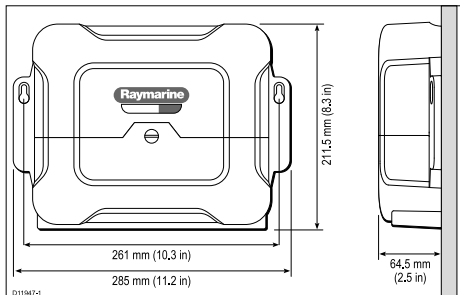

4.2 Installing the SPX course computer

Use this procedure to install the SPX course computer as a part of your inboard autopilot system.

Important: The installation must only be performed with the boat either on hard standing, or tied up alongside a pontoon or berth.

1. Mount the course computer in an appropriate location and secure with the screws supplied.

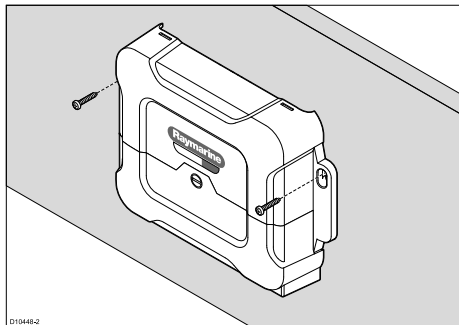

You should also mount the fluxgate compass, autopilot controller and rudder reference unit (if appropriate) at this time.

2. Route the power, data, compass and any other cables required for connection to the course computer.
3. Make all necessary connections into the course computer connector panel.

The connector panel is accessed by removing the cover.

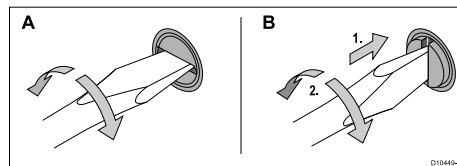

- A — Unlock cover panel
- B — Lock cover panel

After installation you should:

1. Perform an initial power-on test of the system.
2. Commission the system including calibration of the compass and setup of the autopilot characteristics.

Important: Before using the autopilot system it is essential that it is properly commissioned in accordance with the commissioning instructions provided.

4.3 Initial checks for the autopilot installation

These checks should be carried out after installation, and prior to the commissioning of the autopilot system.

1. Switch on power to the autopilot system and associated equipment.
 - Course computer
 - Autopilot controller
 - SeaTalk and/or SeaTalk^{ng} data bus (if these have their own separate supply).
2. Check that the autopilot controller powers up. If the display is blank press and hold the **Power** key for 1 second.
3. Check the display for error messages that could indicate a problem with the installation.

For assistance with diagnosing faults:

- Refer to the troubleshooting information supplied with the product, or
- contact Raymarine customer support.

Note: The autopilots built-in gyro requires a few minutes to stabilize after power on. During this time the heading may appear to drift until the gyro has stabilized.

Chapter 5: Maintenance and support

Chapter contents

- [5.1 Service and maintenance on page 32](#)
- [5.2 Cleaning on page 32](#)
- [5.3 Raymarine customer support on page 32](#)

5.1 Service and maintenance

This product contains no user serviceable components. Please refer all maintenance and repair to authorized Raymarine dealers. Unauthorized repair may affect your warranty.

5.2 Cleaning

1. Switch off the power to the unit.
2. Wipe the unit with a clean, damp cloth.
3. If necessary, use isopropyl alcohol (IPA) or a mild detergent to remove grease marks.

Note: Do NOT use abrasive, or acid or ammonia based products.

5.3 Raymarine customer support

Raymarine provides a comprehensive customer support service. You can contact customer support through the Raymarine website, telephone and email. If you are unable to resolve a problem, please use any of these facilities to obtain additional help.

Web support

Please visit the customer support area of our website at: www.raymarine.com

This contains Frequently Asked Questions, servicing information, e-mail access to the Raymarine Technical Support Department and details of worldwide Raymarine agents.

Telephone and email support

In the USA:

- **Tel:** +1 603 324 7900
- **Toll Free:** +1 800 539 5539
- **Email:** support@raymarine.com

In the UK, Europe, the Middle East, or Far East:

- **Tel:** +44 (0)13 2924 6777
- **Email:** ukproduct.support@raymarine.com

Product information

If you need to request service, please have the following information to hand:

- Product name.
- Product identity.
- Serial number.
- Software application version.

You can obtain this product information using the menus within your product.

Appendix A Technical specification

Nominal supply voltage	12 or 24 V dc
Operating voltage range	10 V to 32 V dc
Fuse / Breakers	Power supply fuse: <ul style="list-style-type: none"> • 15 A (SPX-10, SPX-SOL) • 40 A (SPX-30)
SeaTalk Power out	<ul style="list-style-type: none"> • 2A at 12 V (fuse protected at 2A) — SPX-10 • 3A at 12 V (fuse protected at 3A) — All except SPX-10
SeaTalk ^{ng} Power out	<ul style="list-style-type: none"> • 2A at 12 V (fuse protected at 2A) — SPX-10 • 3A at 12 V (fuse protected at 3A) — All except SPX-10
Power consumption (standby)	300 mA
SeaTalk ^{ng} LEN (Load Equivalency Number)	1
Gyro	Internal GyroPlus fitted as standard
Environmental conditions operating temperature non-operating temperature relative humidity limit water protection	Installation environment <ul style="list-style-type: none"> • Operating temperature: -10 °C to +50 °C (14 °F to 122 °F) • Storage temperature: -20 °C to +65 °C (-4 °F to 149 °F) • Relative humidity: max 95% • Drip resistant when mounted vertically

Dimensions	<ul style="list-style-type: none"> • Width: 285 mm (11.2 in) • Height: 212 mm (8.3 in) • Depth: 65 mm (2.5 in)
Weight	<ul style="list-style-type: none"> • 1.1 kg (2.42 lbs) — SPX-10 • 2.2 kg (4.85 lbs) — SPX-30
Data Connections	<ul style="list-style-type: none"> • NMEA 0183: I/O 4800 baud • SeaTalk^{ng} • SeaTalk
Other connections	Fluxgate compass, Rudder position sensor, Sleep switch, Power, drive motor, drive clutch/SOL bypass valve
Fast heading output	<ul style="list-style-type: none"> • NMEA 0183 — 5 Hz • SeaTalk^{ng} — 10 Hz • NMEA 2000 — 10 Hz
Raymarine drive compatibility X 10 X 30 X SOLENOID	<p>SPX-10</p> <ul style="list-style-type: none"> • all Type 1 drives/pumps (excluding CR pumps). Drive voltage must match boat's supply voltage. <p>SPX-30</p> <ul style="list-style-type: none"> • all Type 1, Type 2 and Type 3 drives / pumps. Drive voltage must match boat's supply voltage. <p>SPX-SOL</p> <ul style="list-style-type: none"> • CR pumps and solenoid drive

Drive current output	<p>SPX-10</p> <ul style="list-style-type: none"> • Continuous 10A at supply voltage • Peak (Limit) 25 A • Continuous 30A at supply voltage (SPX-30) <p>SPX-30</p> <ul style="list-style-type: none"> • Continuous 30A at supply voltage (SPX-30) • Peak (Limit) 50 A
Drive clutch output X 10 X 30 X SOLENOID	<ul style="list-style-type: none"> • 2.0 A at 12 / 24 V selectable (SPX-10, SPX-SOL) • 3.0 A at 12 / 24 V selectable (SPX-30)
EMC compliance:	<ul style="list-style-type: none"> • Europe: 2004/108/EC • Australia and New Zealand: C-Tick, Compliance Level 2

Appendix B NMEA 0183 sentences

SPX course computers with an NMEA 0183 input/output support the following sentences.

Receive (NMEA 0183 in)

APB	Autopilot B
BWC	Bearing and distance to waypoint
BWR	Bearing and distance to waypoint rhumb line
DTM	Local datum in use
GGA	Global positioning system fix data
GLL	Geographic position latitude longitude
HDG	Heading deviation and variation
HDM	Heading magnetic
HDT	Heading true
MWW	Apparent wind angle (AWA) and apparent wind speed (AWS)
RMA	Recommended minimum specific Loran C data
RMB	Recommended minimum navigation information
RMC	Recommended minimum specific GPS transit data
VHW	Speed through water and heading

VTG	Course over ground (COG) and speed over ground (SOG)
VWR	Apparent wind angle (AWA) and apparent wind speed (AWS)
XTE	Cross track error
ZDA	Time and date

Transmit (NMEA 0183 out)

HDG	Heading deviation and variation
HDT	True heading (requires true heading data to be available.)
RSA	Rudder angle (requires rudder reference unit)

Appendix C SeaTalk^{ng} cables and accessories

SeaTalk^{ng} cables and accessories for use with compatible products.

Description	Part No	Notes
Backbone Kit	A25062	Includes: <ul style="list-style-type: none"> • 2 x 5 m (16.4 ft) Backbone cable • 1 x 20 m (65.6 ft) Backbone cable • 4 x T-piece • 2 x Backbone terminator • 1 x Power cable
SeaTalk ^{ng} 0.4 m (1.3 ft) spur	A06038	
SeaTalk ^{ng} 1 m (3.3 ft) spur	A06039	
SeaTalk ^{ng} 3 m (9.8 ft) spur	A06040	
SeaTalk ^{ng} 5 m (16.4 ft) spur	A06041	
SeaTalk ^{ng} 0.4 m (1.3 ft) backbone	A06033	
SeaTalk ^{ng} 1 m (3.3 ft) backbone	A06034	
SeaTalk ^{ng} 3 m (9.8 ft) backbone	A06035	
SeaTalk ^{ng} 5 m (16.4 ft) backbone	A06036	

Description	Part No	Notes
SeaTalk [®] 9 m (29.5 ft) backbone	A06068	
SeaTalk [®] 20 m (65.6 ft) backbone	A06037	
SeaTalk [®] to bare ends 1 m (3.3 ft) spur	A06043	
SeaTalk [®] to bare ends 3 m (9.8 ft) spur	A06044	
SeaTalk [®] Power cable	A06049	
SeaTalk [®] Terminator	A06031	
SeaTalk [®] T-piece	A06028	Provides 1 x spur connection
SeaTalk [®] 5-way connector	A06064	Provides 3 x spur connections
SeaTalk to SeaTalk [®] converter	E22158	Allows the connection of SeaTalk devices to a SeaTalk [®] system.
SeaTalk [®] Inline terminator	A80001	Provides direct connection of a spur cable to the end of a backbone cable. No T-piece required.
SeaTalk [®] Blanking plug	A06032	
SeaTalk (3 pin) to SeaTalk [®] adaptor cable 0.4 m (1.3 ft)	A06047	

Description	Part No	Notes
SeaTalk2 (5 pin) to SeaTalk [®] adaptor cable 0.4 m (1.3 ft)	A06048	
DeviceNet adaptor cable (Female)	A06045	Allows the connection of NMEA 2000 devices to a SeaTalk [®] system.
DeviceNet adaptor cable (Male)	A06046	Allows the connection of NMEA 2000 devices to a SeaTalk [®] system.
DeviceNet adaptor cable (Female) to bare ends.	E05026	Allows the connection of NMEA 2000 devices to a SeaTalk [®] system.
DeviceNet adaptor cable (Male) to bare ends.	E52027	Allows the connection of NMEA 2000 devices to a SeaTalk [®] system.

Appendix D SeaTalk accessories

SeaTalk cables and accessories for use with compatible products.

Description	Part No	Notes
3-way SeaTalk junction box	D244	
1 m (3.28 ft) SeaTalk extension cable	D284	
3 m (9.8 ft) SeaTalk extension cable	D285	
5 m (16.4 ft) SeaTalk extension cable	D286	
9 m (29.5 ft) SeaTalk extension cable	D287	
12 m (39.4 ft) SeaTalk extension cable	E25051	
20 m (65.6 ft) SeaTalk extension cable	D288	

Raymarine[®]
A FLIR COMPANY

www.raymarine.com

