

# Raymarine®

## **ST40 Speed Instrument Owner's Handbook**

Document number: 81157-3

Date: March 2006

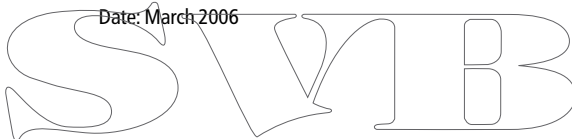

SVIB

## Important information

### Safety notices



**WARNING: Product installation & operation**

**This equipment must be installed and operated in accordance with the Raymarine instructions provided. Failure to do so could result in personal injury, damage to your boat and/or poor product performance.**



**WARNING: Electrical safety**

**Make sure you have switched off the power supply before you start installing this product.**



**WARNING: Navigation aid**

**Although we have designed this product to be accurate and reliable, many factors can affect its performance. Therefore, it should serve only as an aid to navigation and should never replace commonsense and navigational judgement. Always maintain a permanent watch so you can respond to situations as they develop.**

### EMC conformance

All Raymarine equipment and accessories are designed to the best industry standards for use in the recreational marine environment.

The design and manufacture of Raymarine equipment and accessories conform to the appropriate Electromagnetic Compatibility (EMC) standards, but correct installation is required to ensure that performance is not compromised.

### Waste from Electrical and Electronic Equipment (WEEE) Directive



The Waste from Electrical and Electronic Equipment (WEEE) Directive requires the recycling of waste electrical and electronic equipment. Whilst the WEEE Directive does not apply to some of Raymarine's products, we support its policy and ask you to be aware of how to dispose of this product.

The crossed out wheellie bin symbol, illustrated above, and found on our products signifies that this product should not be disposed of in general waste or landfill.

Please contact your local dealer, national distributor or Raymarine Technical Services for information on product disposal.

## **Handbook information**

To the best of our knowledge, the information in this handbook was correct when it went to press. However, Raymarine cannot accept liability for any inaccuracies or omissions it may contain.

In addition, our policy of continuous product improvement may change specifications without notice. Therefore, Raymarine cannot accept liability for any differences between the product and the handbook.

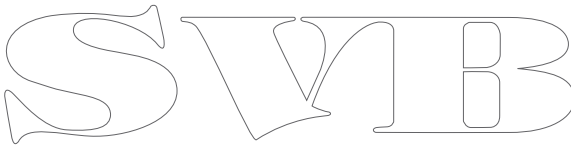
The logo for Raymarine, consisting of the letters 'S', 'V', and 'M' in a stylized, outlined font, followed by the letters 'R', 'A', 'Y', 'M', 'A', 'R', 'I', 'N', 'E' in a similar outlined font.

# Contents

- Important information ..... i**
  - WARNING ..... i
  - EMC conformance ..... i
  - Handbook information ..... i
- Preface ..... v**
  - Parts supplied ..... vi
- Chapter 1: Operation ..... 1**
  - 1.1 Introduction ..... 1
  - 1.2 Operating procedures ..... 1
    - Adjusting display backlighting and contrast ..... 3
- Chapter 2: Maintenance and Fault Finding ..... 5**
  - 2.1 Maintenance ..... 5
    - Serviceing and safety ..... 5
    - Instrument ..... 6
    - Transducer ..... 6
    - Cabling ..... 6
  - 2.2 Fault finding ..... 6
    - Preliminary procedures ..... 6
    - Fixing faults ..... 6
    - Assistance ..... 8
- Chapter 3: Installation ..... 9**
  - 3.1 Planning your installation ..... 9
    - EMC installation guidelines ..... 9
      - Suppression Ferrites ..... 10
      - Connections to Other Equipment ..... 10
    - Tools required ..... 10

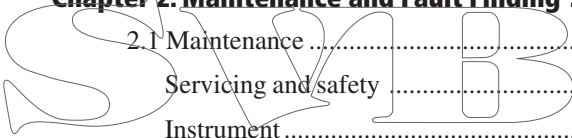

Site requirements .....	11
Transducer .....	11
Instrument .....	13
3.2 Procedures .....	13
Fitting transducer .....	13
Running transducer cable .....	14
Connections to the instrument .....	14
Stand-alone connections .....	15
SeaTalk connections .....	16
Fitting the instrument .....	16
3.3 Calibration requirement .....	19
<b>Chapter 4: Calibration .....</b>	<b>21</b>
4.1 Introduction .....	21
EMC conformance .....	21
4.2 User calibration .....	21
4.3 Intermediate calibration .....	23
4.4 Dealer calibration .....	23
<b>Instrument Specification .....</b>	<b>25</b>
<b>Glossary .....</b>	<b>27</b>
<b>Index .....</b>	<b>29</b>

# Preface

Thank you for purchasing a Raymarine product. We are sure your ST40 instrument will give you many years of trouble-free operation.

This instrument is designed to provide reliable performance, even under the most demanding conditions.

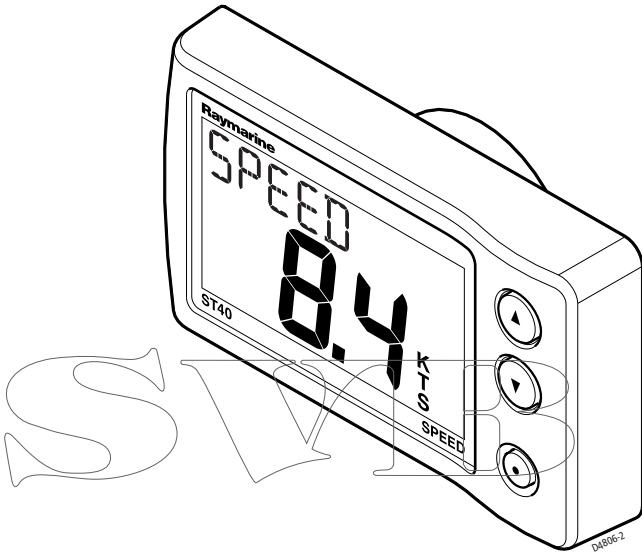

# Parts supplied

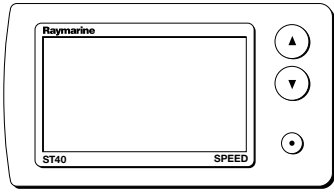

ST40 Speed instrument

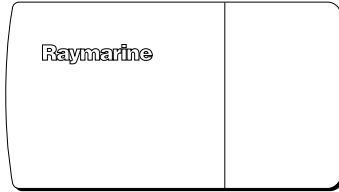

Instrument Cover

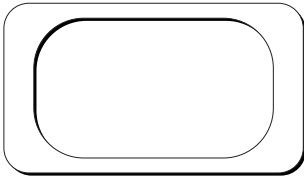

Gasket

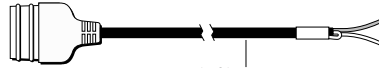

1 m (3 ft) power cable

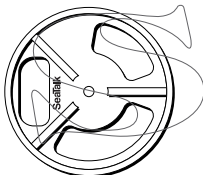

Clamping bracket

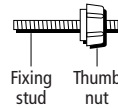
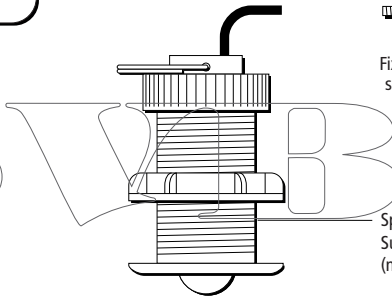

Fixing stud  
Thumb nut

Speed transducer  
Supplied with bung  
(not illustrated)



Owner's Handbook.  
Warranty document and fitting  
templates included in Handbook

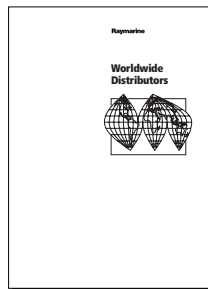

Worldwide Service Centre  
Handbook.

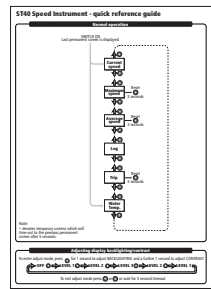

Quick Reference Guide

**Note:**

The items shown here are supplied for an ST40 Speed system. If an instrument is purchased separately, a transducer is not included. If any item is not present, contact your Raymarine Dealer.



# Chapter 1: Operation

## 1.1 Introduction

Your ST40 Speed instrument provides:

- Speed information (current, maximum and average), in either knots (KTS), miles per hour (MPH) or kilometres per hour (KPH).
- Log and trip information. These are given in either nautical miles (NM), statute miles (M) or kilometres (KM).
- Water temperature information. This is given in either degrees Celsius (°C) or Fahrenheit (°F).

**Note:** *The required speed, distance and water temperature units are selected during User calibration (see Chapter 4, Calibration).*

### CAUTION

**Your instrument is calibrated to factory (default) settings when first supplied and must therefore be calibrated before use, to ensure optimum performance on your vessel. Do NOT use the instrument until the calibration procedures have been satisfactorily completed, using the procedures in Chapter 4, Calibration.**

Coloured bezel and Desktop Mounting Bracket options are available for your ST40 instrument. Contact your Raymarine dealer for further information.

## 1.2 Operating procedures

Operating information is presented in flow chart form. The flow charts show the various operating screens and key presses necessary to carry out the various instrument functions. Key presses are momentary unless otherwise stated.

Note that:

- The maximum speed reading is reset to zero at power up.
- The average speed reading is reset to zero at power up.
- The Log screen shows the total distance covered by the vessel since the ST40 Speed instrument was fitted.
- The trip reading is reset to zero at power up.

### NORMAL OPERATION

Switch on

The permanent screen selected at last switch off, is displayed.  
**(Current speed or Water temperature)**

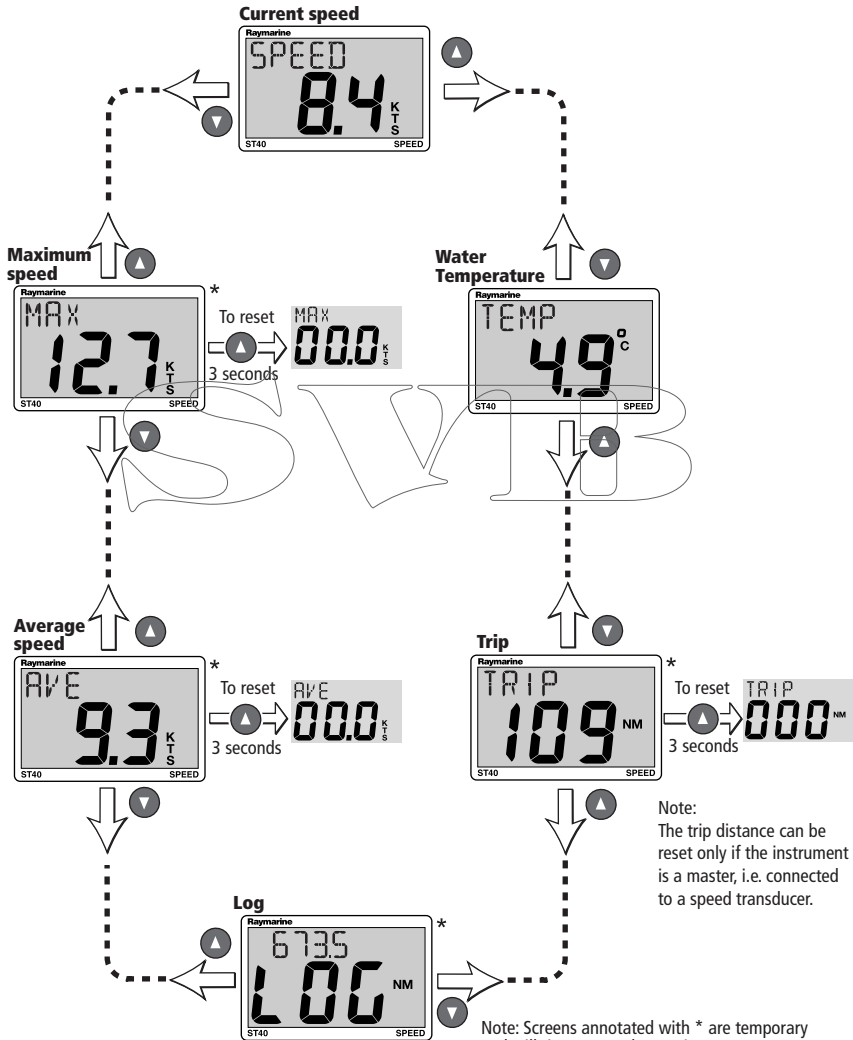

Note:  
The trip distance can be reset only if the instrument is a master, i.e. connected to a speed transducer.

Note: Screens annotated with \* are temporary and will time-out to the previous permanent screen (**Current speed or Water temperature**) after 5 seconds.

# Adjusting display backlighting and contrast

Hold down  for 1 second to enter Adjust Backlight mode  
 for 2 seconds to move through Adjust Backlight mode and enter Adjust Contrast mode

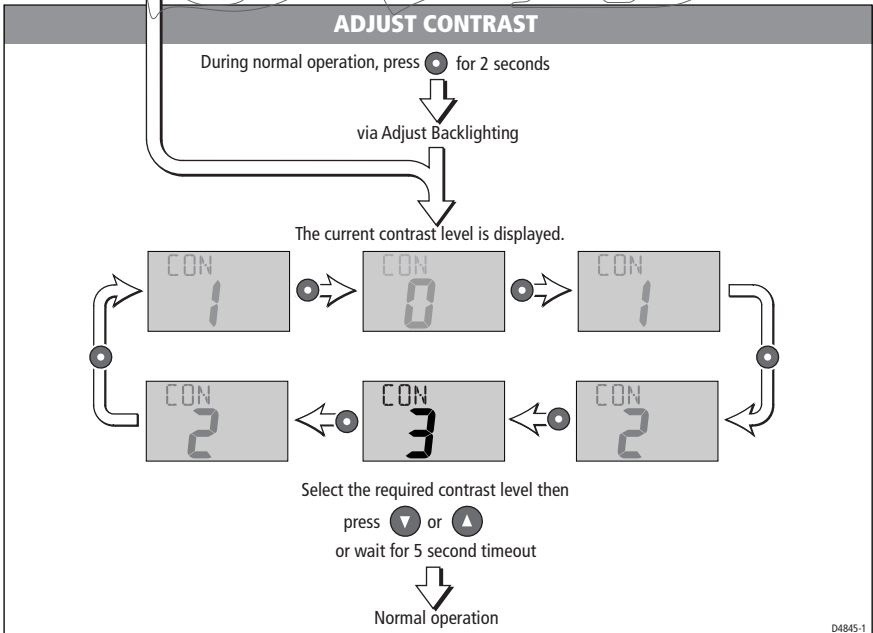
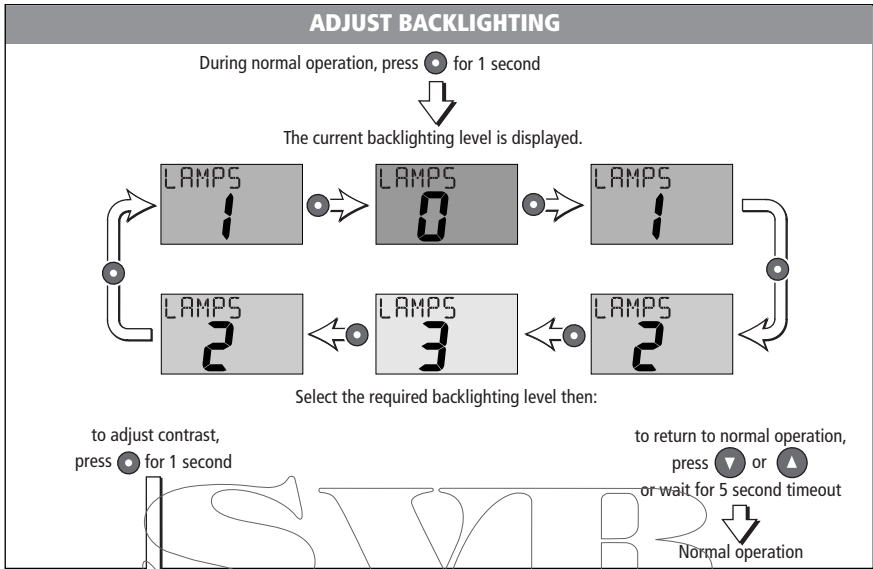

SVIB

# Chapter 2: Maintenance and Fault Finding

## 2.1 Maintenance

### Servicing and safety

- Raymarine equipment should be serviced only by authorised Raymarine service technicians. They will ensure that service procedures and replacement parts used will not affect performance. There are no user-serviceable parts in any Raymarine product.
- Some products generate high voltages, so never handle the cables/connectors when power is being supplied to the equipment.
- When powered up, all electrical equipment produces electromagnetic fields. These can cause adjacent pieces of electrical equipment to interact with one another, with a consequent adverse affect on operation. In order to minimise these effects and enable you to get the best possible performance from your Raymarine equipment, guidelines are given in the installation instructions, to enable you to ensure minimum interaction between different items of equipment, i.e. ensure optimum Electromagnetic Compatibility (EMC).
- Always report any EMC-related problem to your nearest Raymarine dealer. We will use any such information to improve our quality standards.
- In some installations, it may not be possible to prevent the equipment from being affected by external influences. In general this will not damage the equipment but it can lead to spurious resetting action, or momentarily may result in faulty operation.
- Always switch off the power to Raymarine equipment before working on it.

When requesting service, please quote equipment Type, Model Number, Serial Number and, if possible, Software Release Issue. The Software Release Issue can be ascertained by means of the Intermediate Calibration facility, see *Chapter 4, Calibration*.

## Instrument

Certain atmospheric conditions may cause a small amount of condensation to form on the instrument window. This will not harm the instrument and will clear after the instrument has been switched on for a short period.

Periodically clean your ST40 instrument with a soft damp cloth. Do NOT use chemical or abrasive materials to clean the instrument.

## Transducer

Refer to the Installation and Maintenance instructions supplied with the transducer.

## Cabling

Examine all cables for chafing or other damage to the outer shield and, where necessary, replace and re-secure.

## 2.2 Fault finding

### Preliminary procedures

If you appear to have a problem, first check the security of the connections at the rear of the instrument and reconnect any that are loose.

Changes in the electronic environment may adversely affect the operation of your ST40 equipment. Typical examples of such changes are:

- Electrical equipment has recently been installed or moved aboard your vessel.
- You are in the vicinity of another vessel or shore station emitting radio signals.

## Fixing faults

All Raymarine products are subjected to comprehensive test and quality assurance programmes prior to packing and shipping. However, if a fault occurs, the following guidelines may help to identify and rectify the problem.

**Low battery**

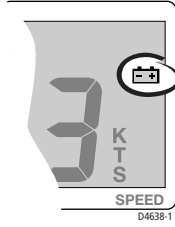

**Action**

Recharge your vessel's battery as soon as possible

**Display blank**

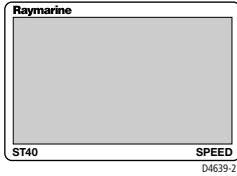

**Action**

Check fuse/circuit breaker.

Check power supply.

Check SeaTalk cabling and connector security.

**No speed or water temperature information**

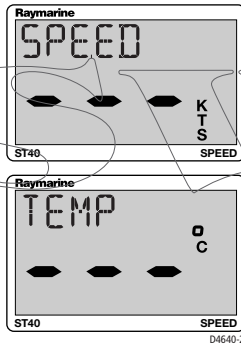

**Action**

Check the condition of the transducer cable and the security of the connections.

**No speed information but water temperature information is present**

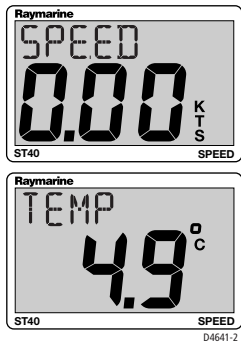

**Action**

Transducer paddle wheel may be fouled.

**CAUTION**

If you need to remove the transducer insert, have the transducer bung to hand and secure it in the transducer body immediately after the insert has been removed, to prevent excessive ingress of water.

Clean the paddle wheel.

**SeaTalk information not being transferred between instruments**

For example, backlighting level changes implemented at one instrument do not affect other instruments

**Action**

Check security of SeaTalk connections between instruments.

Check condition of SeaTalk cables.

Isolate faulty instrument by disconnecting instruments one by one.

**A group of SeaTalk instruments not working**

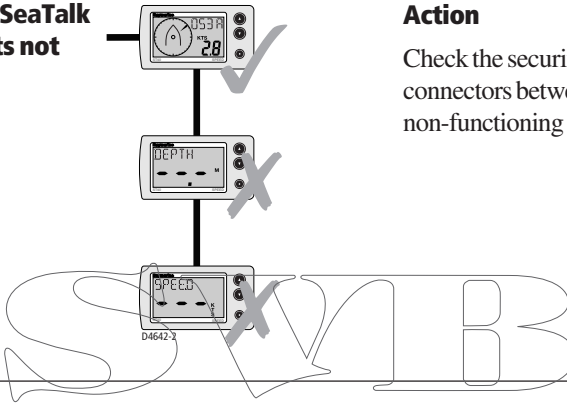

**Action**

Check the security of SeaTalk connectors between functioning and non-functioning instruments.

**Assistance**

If you are unable to rectify any problem, please contact your local Raymarine Dealer for assistance.



# Chapter 3: Installation

This chapter describes how to install the ST40 Speed instrument, and associated speed transducer. The transducer is fitted in the hull of the vessel and is connected to the rear of the instrument.

## 3.1 Planning your installation

Determine the best positions for both transducer and instrument, such that the *EMC installation guidelines* and the *Site requirements* (below) are satisfied.

### EMC installation guidelines

All Raymarine equipment and accessories are designed to the best industry standards for use in the leisure marine environment.

Their design and manufacture conform to the appropriate Electromagnetic Compatibility (EMC) standards, but correct installation is required to ensure that performance is not compromised. Although every effort has been taken to ensure that they will perform under all conditions, it is important to understand what factors could affect the operation of the product.

The guidelines given here describe the conditions for optimum EMC performance, but it is recognised that it may not be possible to meet all of these conditions in all situations. To ensure the best possible conditions for EMC performance within the constraints imposed by any location, always ensure the maximum separation possible between different items of electrical equipment.

For **optimum** EMC performance, it is recommended that **wherever possible**:

- All Raymarine equipment and cables connected to it are:
  - At least 1 m (3 feet) from any equipment transmitting or cables carrying radio signals e.g. VHF radios, cables and antennas. In the case of SSB radios, the distance should be increased to 2 m (7 ft).
  - More than 2 m (7 ft) from the path of a radar beam. A radar beam can normally be assumed to spread 20 degrees above and below the radiating element.

- The equipment is supplied from a different battery from that used for engine start. Voltage drops below 10 V in the power supply to our products, and starter motor transients, can cause the equipment to reset. This will not damage the equipment, but may cause the loss of some information and may change the operating mode.
- Raymarine specified cables are used at all times. Cutting and rejoining these cables can compromise EMC performance and so must be avoided unless doing so is detailed in the installation manual.
- If a suppression ferrite is attached to a cable, this ferrite should not be removed. If the ferrite needs to be removed during installation it must be reassembled in the same position.

### Suppression Ferrites

The following illustration shows typical cable suppression ferrites fitted to Raymarine equipment. Always use the ferrites supplied by Raymarine.

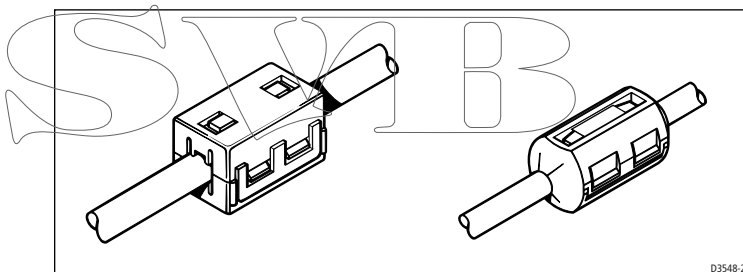

### Connections to Other Equipment

If your Raymarine equipment is going to be connected to other equipment using a cable not supplied by Raymarine, a suppression ferrite **MUST** always be fitted to the cable close to the Raymarine unit.

### Tools required

The tools required for fitting the standard ST40 instrument system are shown in the following illustration.

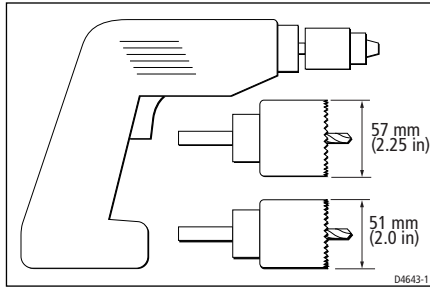

**Note:** *If you intend fitting a nonstandard transducer, extra tools may be required*

## Site requirements

### Transducer

The transducer types required for the various hull types are as follows:

Hull material	Transducer type
Glass reinforced plastic (GRP) Steel Aluminium	M78712 Through hull plastic (supplied as standard)
Wood	M78716 Through hull bronze

Other transducer types are also available for specific requirements. For further details, contact your local Raymarine dealer.

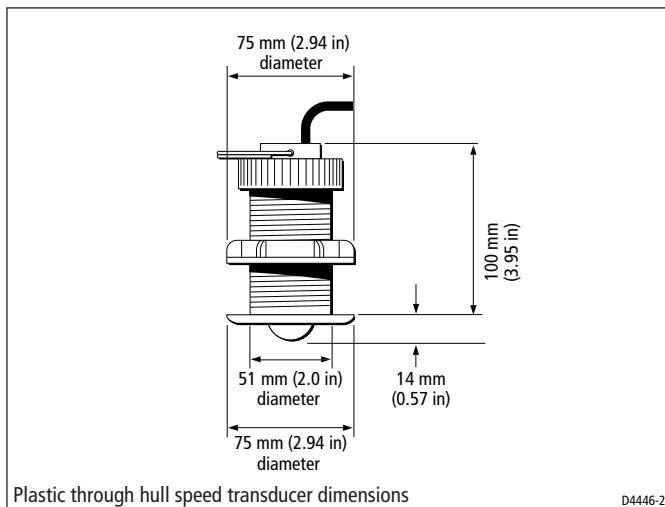

D4446-2

The transducer should:

- Be ahead of the propellers (by a minimum of 10% of the water line length).
- Be at least 150 mm (6 in) away from the keel (ideally ahead of the keel if a sailing yacht).
- Be as near as possible to the centre line of the vessel.
- Be clear of other through-hull fittings or projections.
- Have sufficient clearance inside the hull to fit the nut.
- Have 100 mm (4 in) of headroom to allow for withdrawal.

The transducer should be sited within the clear water flow areas indicated by the shaded areas in the following diagram.

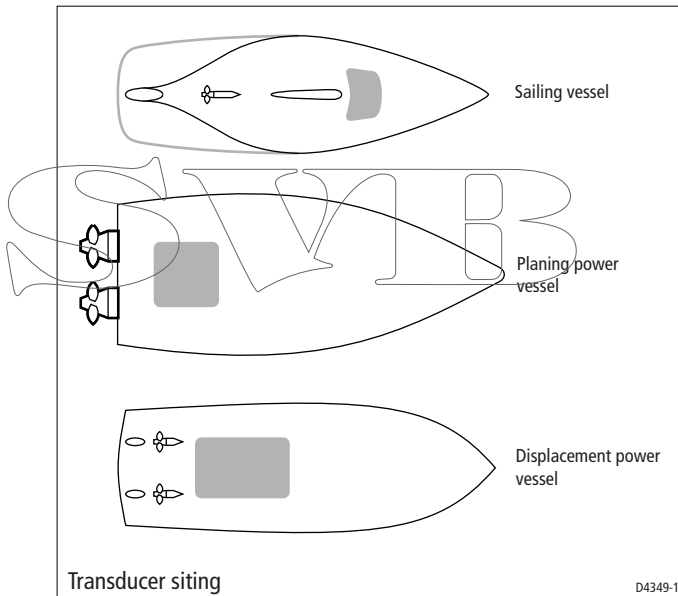

## Instrument

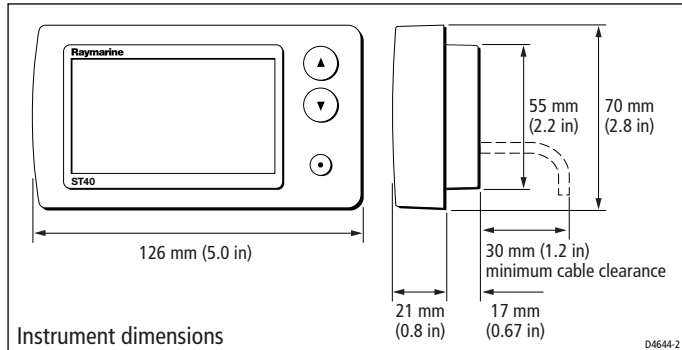

### CAUTION:

**The presence of moisture at the rear of the instrument could cause damage either by entering the instrument through the breathing hole or by coming into contact with the electrical connectors.**

Each instrument must be positioned where:

- It is easily read by the helmsman or navigator
- It is protected against physical damage
- It is at least 230 mm (9 in) from a compass
- There is reasonable rear access for installation and servicing
- The rear of the instrument is protected from water.

## 3.2 Procedures

Adapt these procedures as appropriate, to suit your individual requirement.

### CAUTION:

**Where it is necessary to cut holes (e.g. for cable routing and instrument mounting), ensure that these will not cause a hazard by weakening critical parts of the vessel's structure. If in doubt, seek advice from a reputable boat builder.**

## Fitting transducer

Instructions for installing and maintaining the speed transducer are packed with it. Before attempting to install the transducer, read these instructions and the *Site requirements* for transducers described in this Chapter.

## Running transducer cable

Each transducer has a 9 m (30 ft) cable fitted with spade terminals for connection to the ST40 Speed instrument. Observing the following guidelines, run the cable to the instrument:

- If the cable has to be fed through the deck, always use a good quality deck gland.
- Where cables are fed through holes, always use grommets to prevent chafing.
- Secure long cable runs so they do not present a hazard.
- Wherever possible, route the cable away from fluorescent lights, engines, radio transmitting equipment, as these may cause interference.

## Connections to the instrument

You can connect your instrument:

- Directly to the speed transducer as a stand-alone master instrument. When connected in this manner, the instrument must be connected to a suitable power source using the 1 m (3 ft) power cable provided.
- As part of a SeaTalk system either as a repeater or, with a transducer also connected as a system master. To connect to SeaTalk, you will need an additional SeaTalk Interconnection Kit, (Part No. E25028). When connected in this manner, power can be provided from the SeaTalk bus (e.g. from the autopilot).

You can also connect the instrument to both the speed transducer and SeaTalk. When thus connected, the instrument will be the master speed instrument for the SeaTalk system.

If it is necessary to fit spade connectors to the transducer cable, do so as shown in the following illustration. Prepare the cable, as at (a), and fit the spade connectors, as at (b). When fitting each spade connector, ensure that wire strands do not extend beyond the rear of the spade connector insulation.

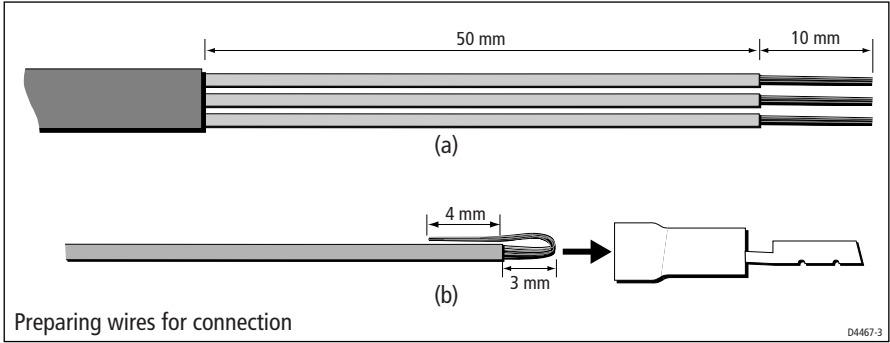

### Stand-alone connections

#### CAUTION

Ensure that the power supply for each stand-alone ST40 instrument is protected by a 3 A fuse or circuit breaker.

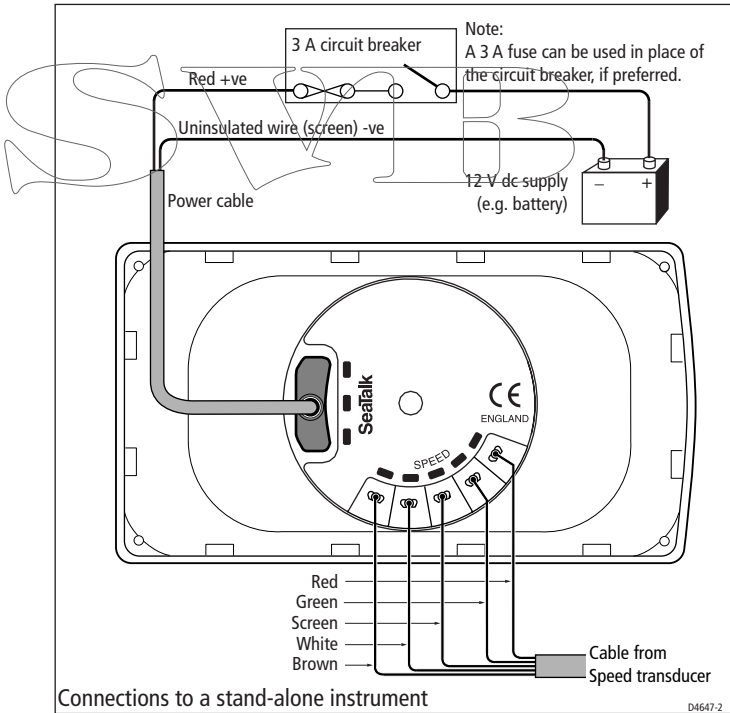

## SeaTalk connections

### CAUTION

When instruments are connected to SeaTalk, ensure that the power supply for the SeaTalk 12 V line is protected by a 5 A fuse or circuit breaker.

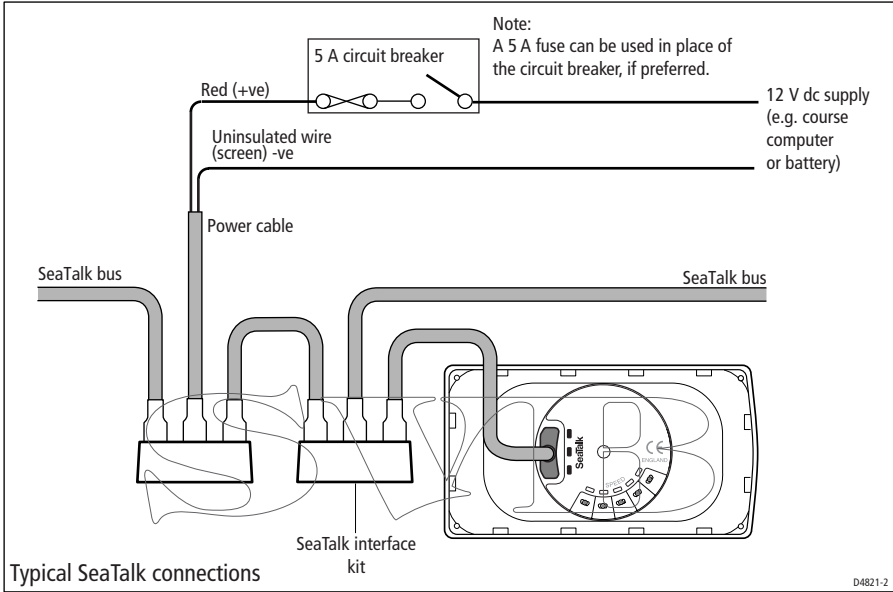

## Fitting the instrument

Fit your ST40 instrument as shown in the following illustrations.

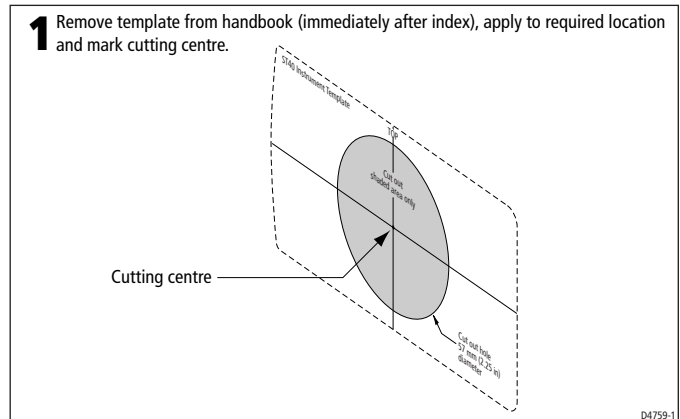



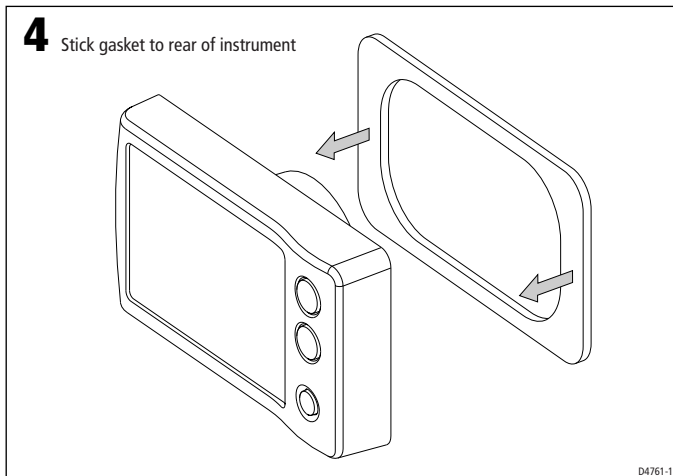
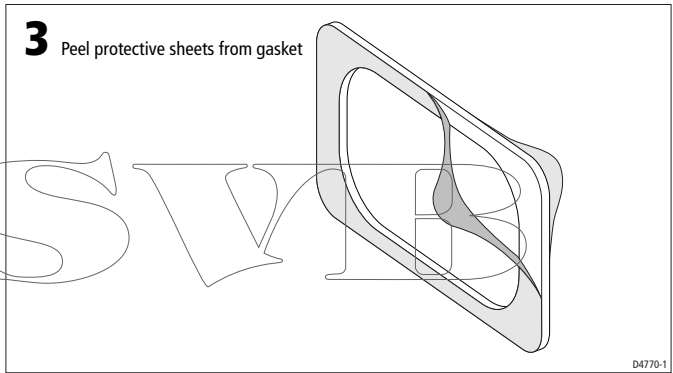
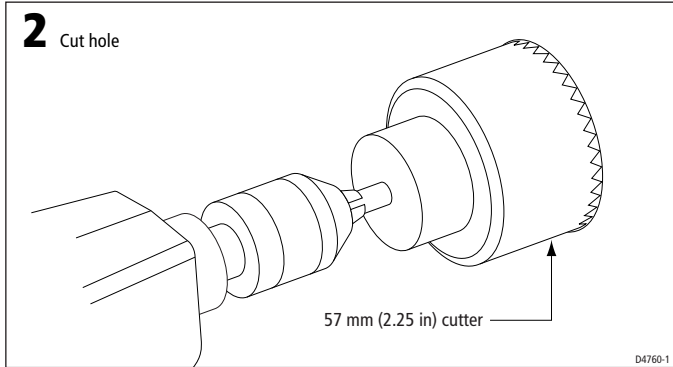

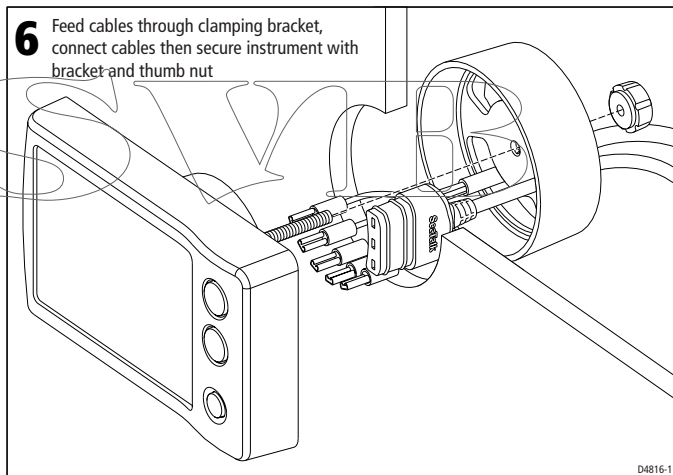
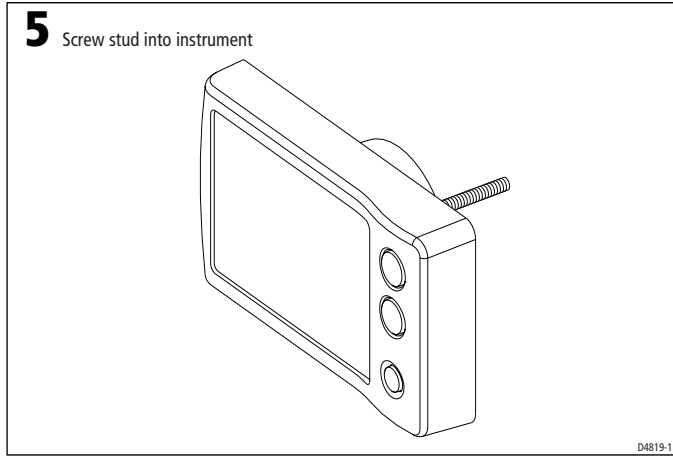

## Desktop Mounting Bracket

An optional Desktop Mounting Bracket (Part No. E25024) enables you to mount your ST40 instrument in locations where other forms of mounting are impractical.

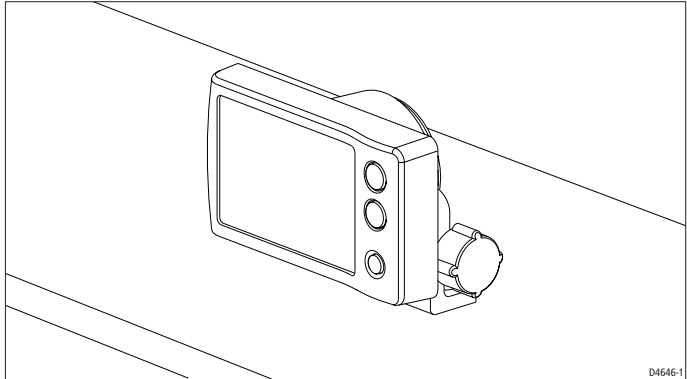

To bracket mount your ST40 instrument, do so in accordance with the *Instruction Sheet*, which is included with the Desktop Mounting Bracket.

### 3.3 Calibration requirement

Once installation is complete and before you use your instrument, carry out the calibration procedures detailed in *Chapter 4, Calibration*.

ST40

SVIB

# Chapter 4: Calibration

## 4.1 Introduction

The procedures in this Chapter must be carried out before the equipment is used operationally, to optimise the performance of the instrument with the vessel.

Calibration information is presented in flow chart form. The flow charts show the various calibration screens and key presses necessary to carry out calibration. All key presses are momentary unless otherwise stated.

### EMC conformance

Always check the installation before going to sea to make sure that it is not affected by radio transmissions, engine starting etc.



## 4.2 User calibration

User calibration enables you to:

- Set the required units for speed readings. Either KTS (knots), MPH (miles per hour) or KPH (kilometres per hour).
- Set the required distance units. Either NM (nautical miles), SM (statute miles) or KM (kilometres).
- Select water temperature units. Either °C or °F, as required.
- Set the speed display response. Use higher response values when boating in conditions requiring rapid updates of the current speed (e.g. competition sailing or on power boats). Use slower response values when you require an average speed over a longer period of time (e.g. when cruising, especially in heavy seas).
- Set the correct speed reading, either by using a **Cal factor** screen to adjust the calibration factor, or by applying Speed Over Ground (SOG) as the current speed. Your vessel must be moving at 0.5 KTS or more and be receiving SeaTalk SOG data, to enable SOG to be applied as the current speed. This should be done only in conditions of zero tide and current.

To carry out User calibration, power up the instrument then follow the procedure in the *User calibration* flow diagram.

## USER CALIBRATION

During normal operation  
hold down  and  for approximately 2 seconds

**Entry screen**

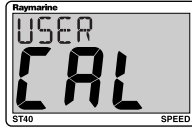

**Note:**  
If there is no key activity when the **Entry screen** is displayed, calibration will time out to normal operation after 5 seconds,

**Speed response**



15 (fast)

1 (slow)

**Speed units**



KPH

MPH

**Distance units**



KM

SM

**Water temperature units**

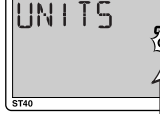

F

2.5 (increase speed)

0.25 (decrease speed)

**Cal factor**

1.05

12.8



**Set to SOG**



Displayed only if SOG available on SeaTalk & vessel speed greater than 0.5 kt

To apply SOG value as speed reading, press  for 3 seconds, in conditions of zero tide and current

**Note:**  
Screens other than the **Entry screen** and the **Speed response** screen are available only on master instruments.

To save your settings and return to normal operation from any screen,  
hold down  and  for approximately 2 seconds

## 4.3 Intermediate calibration

Intermediate calibration enables you to:

- Check the instrument software version.
- Check and if necessary set, the instrument status - either MASTR (master) or REPTR (repeater).

Follow the procedure in the *Intermediate calibration* flow diagram.

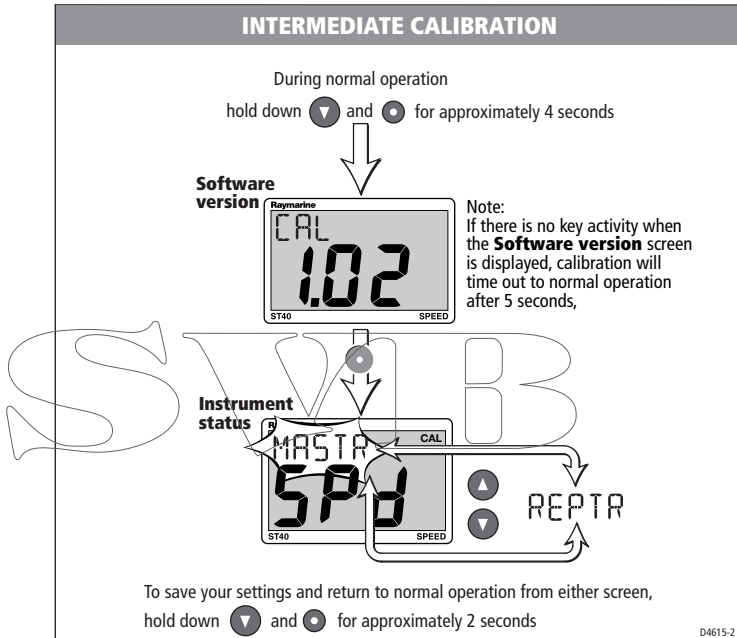

## 4.4 Dealer calibration



Dealer calibration enables you to set:

- User calibration on/off.
- Boat show mode on/off.

Dealer calibration also gives access to the **Factory defaults** screen. This enables you to reapply the factory settings if you want to reset the instrument to a known operating condition.

Follow the procedure in the *Dealer calibration* flow diagram.

### DEALER CALIBRATION

During normal operation  
hold down  and  for approximately 12 seconds

**Entry screen**

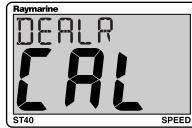

Note:  
If there is no key activity when the **Entry screen** is displayed, calibration will time out to normal operation after 5 seconds,

**Calibration access**

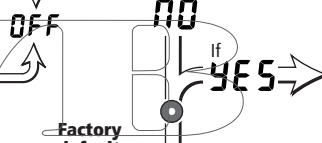
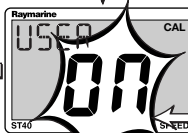

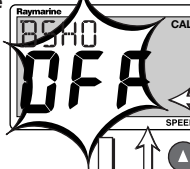

**Boat show mode**

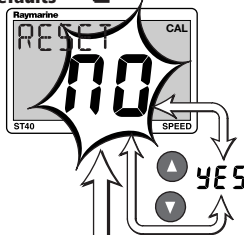

**CAUTION:**  
Do NOT switch the Boat Show mode on.  
This function must only be used for demonstration purposes.

**Factory defaults**



To save your settings and return to normal operation from any screen,  
hold down  and  for approximately 2 seconds



# Instrument Specification

<b>Supply voltage:</b>	10 V to 16 V dc.
<b>Current consumption (12 V supply):</b>	25 mA typical. 60 mA with maximum backlighting.
<b>Operating temperature:</b>	0°C to +70°C.
<b>Interfaces:</b>	SeaTalk.
<b>Overall dimensions:</b>	126 mm x 70 mm x 38 mm (5.00 inches x 2.80 inches x 1.55 inches).
<b>Boss diameter:</b>	55 mm (2.20 inches).
<b>Speed range:</b>	0 to 99.9 knots.
<b>Log range:</b>	0 to 99999.
<b>Trip range:</b>	0 to 999 nautical miles.
<b>Water temperature reading range:</b>	-10°C to +40°C.
<b>Approvals:</b>	
<b>CE - conforms to</b>	89/336/EC(EMC), EN60945. 94/25/EC(RCD), EN28846 (applies to transducer only).

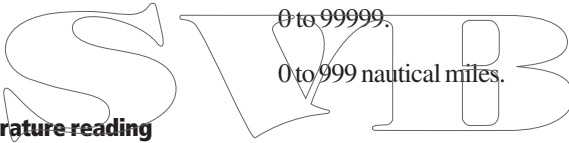

SVIB

# Glossary

- Cal factor** Calibration factor. Used in ST40 Speed and Bidata instruments to ensure the current speed reading is the actual speed. Values are from 0.25 (reduce speed reading) to 2.5 (increase speed reading).
- EMC** Electromagnetic Compatibility.
- KPH** Kilometres Per Hour.
- KTS** Knots.
- MPH** Miles Per Hour.
- NM** Nautical Miles.
- Response** Determines the rate at which an instrument responds to changes in boat speed. Values are from 1 (slow response) to 15 (fast response).
- SeaTalk** SeaTalk is a proprietary Raymarine system which links different compatible products, to provide a single, integrated navigational system. SeaTalk can also communicate with non-SeaTalk equipment using the internationally-accepted National Marine Electronics Association (NMEA) protocol. Contact your Raymarine dealer for details.

SVIB

# Index

## A

Average speed reset 2

## B

Backlighting 3

Boat show mode 23

## C

Calibration 21–24

Dealer 23–24

Intermediate 23

setting appropriate response values 21–24

setting user access 24

User 21–22

Calibration requirement 1, 19

Cleaning the instrument 6

Condensation 6

Connecting the instrument 14–16

Contrast 3

Current consumption 25

## D

Dealer calibration 23–24

Desktop Mounting Bracket 18–19

Dimensions 25

Display

backlighting 3

contrast 3

## E

EMC

conformance i, 21

installation guidelines 9–10

## F

Factory defaults

setting 23

Fault finding 6

assistance 8

blank display 7

low battery 7

no speed information 7

no speed or water temperature information 7

SeaTalk problems 8

## I

Installation 9–19

connecting the instrument 14–16

EMC guidelines 9–10

fitting the instrument 16–19

planning 9–13

procedures 13–19

site requirements 11–13

tools required 10–11

transducer 14

Instrument

cleaning 6

condensation 6

connecting 14–16

current consumption 25

dimensions 25

fitting 16–19

site requirements 13

status (master or repeater) 23

supply voltage 25

Intermediate calibration 23

## L

Log distance 1

range 25

## M

Maintenance 5–6

Maximum speed 1

Maximum speed reset 2

**N**

Normal operation 2–3

**O**

Operating procedures 1–3

Operating temperature 25

**P**

Panel lighting 3

Parts supplied vi

**R**

Reset

average speed 2

maximum speed 2

trip distance 2

**S**

Servicing and safety 5

Setting

backlighting 3

calibration factor 22

contrast 3

correct speed 22

speed response 22

speed to SOG 22

speed units 22

water temperature units 22

Site requirements 11–13

instrument 13

transducer 11–12

Software version 23

Specifications 25

Speed

appropriate response values 21

average 1

calibration factor 27

current 1

maximum 1

range 25

response 27

setting response 22

setting units 22

**T**

Transducer

fitting 14

site requirements 11–12

Trip distance 1

Trip distance reset 2

Trip range 25

**U**

User calibration 21–22

**V**

Voltage 25

**W**

Water temperature 1

range 25

setting units 22

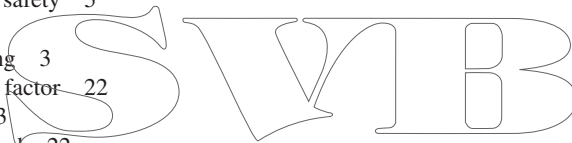

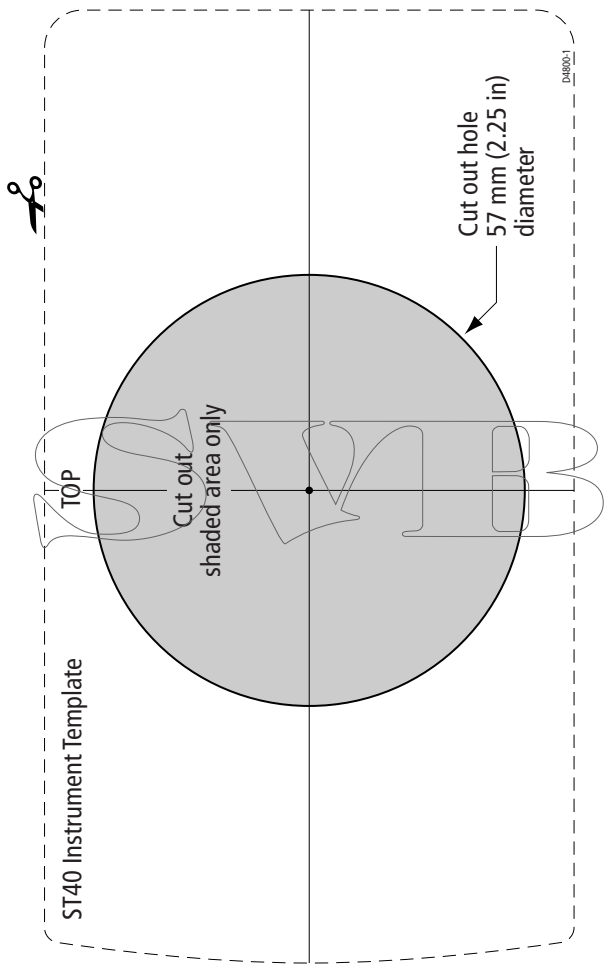

SVIB



# Raymarine World Wide Warranty

## Raymarine Inc.

APPLICABLE TO PRODUCTS SOLD THROUGH OFFICIAL RAYMARINE INC. DEALERS, DISTRIBUTORS AND BOAT BUILDERS WITHIN THE AMERICAS AND CARIBBEAN.

### Limited warranty

Subject to the terms, conditions and limitations set forth in this U.S. Limited Warranty (hereinafter the 'Warranty'), Raymarine warrants that its products, when properly installed and used, will be free from defects in material and workmanship for a period of twenty-four (24) months (with respect to VHF radios, a period of thirty-six (36) months), from the date of first purchase (the 'Warranty Period').

For the purposes of this warranty, 'date of first purchase' means the date that the product was purchased by the first retail customer; or in the case of a product installed on a new vessel by a certified Raymarine original equipment manufacturer (a 'Raymarine OEM'), the date that such vessel was purchased by the first retail customer.

Raymarine will, at its sole option, repair or replace any defective products or components returned during the Warranty Period in accordance with the terms, conditions and limitations set forth below. **Such repairs or replacement will be the sole remedy of the customer under this Warranty.**

### Obtaining Warranty Service

#### Standard Warranty Service

To qualify for standard warranty service the product must be returned to a Raymarine-certified service agent, or directly to Raymarine in person, or by mail (i) within the Warranty Period, and (ii) within thirty (30) days of the alleged product failure. Any products returned by mail must be securely packaged and sent pre-paid and insured to Raymarine or to a Raymarine-certified service agent. All products, whether returned in person or by mail, must be accompanied by a copy of the original sales receipt, to be eligible for standard warranty service.

A list of Raymarine-certified service agents is available from Raymarine Technical Support or at [www.raymarine.com](http://www.raymarine.com)

#### 'On Board' Warranty Service

For any Raymarine product or system that (i) has been installed on your vessel by a Raymarine-certified service agent or by a Raymarine OEM, and (ii) has a MSRP equal to or greater than USD \$2,500, you are eligible to receive warranty service by a Raymarine certified service agent on-board your vessel ('On Board Warranty Service') for a period of 12 months from the date of first purchase of such product or system, or the date of first purchase of the vessel on which such product or system has been installed (the 'On Board Warranty Period'). In order to obtain On Board Warranty Service eligible customers **MUST**:

- (i) within the On Board Warranty Period, and (ii) within thirty (30) days from the date of the alleged failure giving rise to the warranty claim for which you are requesting On Board Warranty Service, contact a local Raymarine-certified service agent and request On Board Warranty Service.
- Present to the Raymarine-certified service agent a copy of the original sales receipt for the product, together with proof of the date of installation of the product by a Raymarine-certified service agent. The service agent may at its sole option, accept or deny such proof of purchase and proof of installation as sufficient to qualify you for On Board Warranty Service.

Costs associated with travel, mileage, taxi fares, launch or docking fees, aircraft or vehicle rental, meals, customs, shipping, communication charges, and service agent travel costs are specifically excluded from coverage under this Warranty and are your responsibility. **In addition**, this Warranty does not cover fees associated with hauling, shipping or towing your vessel to a Raymarine-certified agent.

Upon the expiration of the On Board Warranty Period, you are still eligible to receive standard warranty service for the remaining term of the Warranty Period, but will not be eligible for continued On Board Warranty Service.

### **Limitations and Exclusions**

In addition to any other limitations and exclusions set forth herein, Raymarine is not responsible for, and this Warranty does not cover:

- failures due to abuse, misuse, accident, unauthorized alteration or repair, improper installation (whether or not by a Raymarine-certified service agent), shipping damage or corrosion;
- Costs associated with routine system checkouts, alignment/calibration, sea trials or commissioning;
- repair or replacement of consumable items, including, without limitation, fuses, batteries, drive belts, radar mixer diodes, snap-in impeller carriers, impellers, impeller bearings and impeller shafts;
- costs associated with overtime or premium labor costs;
- differences in material, coloring or size that may exist between actual products and the pictures or descriptions of such products in our advertising, advertising literature or on the Internet;
- products purchased by a customer from a United States dealer via the Internet if such products were not delivered and installed within the United States; or
- the replacement of missing components from the package of any product purchased through an online auction site.

### **Other conditions**

This Warranty is fully transferable provided that you furnish the original proof of purchase to Raymarine or, in the case of On Board Warranty Service, to a Raymarine-certified service agent. This Warranty is void if the label bearing the serial number has been removed or defaced.

**TO THE EXTENT CONSISTENT WITH STATE AND FEDERAL LAW, THE FOREGOING WARRANTY IS RAYMARINE'S SOLE WARRANTY AND IS APPLICABLE ONLY TO NEW PRODUCTS PURCHASED IN THE UNITED STATES OF AMERICA.** THE PROVISIONS OF THIS WARRANTY ARE IN LIEU OF ANY OTHER WRITTEN WARRANTY, WHETHER EXPRESSED OR IMPLIED, WRITTEN OR ORAL, INCLUDING ANY WARRANTY OF MERCHANTABILITY OR FITNESS FOR A PARTICULAR PURPOSE.

THE LIABILITY OF RAYMARINE TO A CUSTOMER UNDER THIS WARRANTY, WHETHER FOR BREACH OF CONTRACT, TORT, BREACH OF STATUTORY DUTY OR OTHERWISE SHALL IN NO EVENT EXCEED AN AMOUNT EQUAL TO TEN (10) TIMES THE MANUFACTURER'S SUGGESTED RETAIL PRICE OF THE PRODUCT GIVING RISE TO SUCH LIABILITY AND IN NO EVENT SHALL RAYMARINE BE LIABLE FOR SPECIAL, INCIDENTAL, CONSEQUENTIAL OR INDIRECT DAMAGES.

SOME JURISDICTIONS DO NOT ALLOW EXCLUSION OR LIMITATION OF INCIDENTAL OR CONSEQUENTIAL DAMAGES SO THE ABOVE LIMITATIONS OR EXCLUSIONS MAY NOT APPLY TO YOU. THIS WARRANTY GIVES YOU SPECIFIC LEGAL RIGHTS AND YOU MAY ALSO HAVE OTHER RIGHTS, WHICH VARY FROM JURISDICTION TO JURISDICTION.

This Warranty supersedes and replaces all previous Warranties.

January 2005

## Raymarine UK Ltd.

APPLICABLE TO PRODUCT SOLD THROUGH OFFICIAL RAYMARINE UK LTD. DEALERS, DISTRIBUTORS AND BOAT BUILDERS WITHIN EUROPE, THE MIDDLE AND FAR EAST, AFRICA AND AUSTRALASIA.

### Limited Warranty

The Raymarine warranty terms and conditions as described below do not affect the customers legal rights and complies with EU Directive 1999/44/EC.

In order to ensure that the product continues to operate efficiently and reliably, we recommend that, before using the product, the customer carefully reads the Owner's Handbook and follows the advice on the safe and correct operation and use of the product. We recommend that the Raymarine product is installed by a Raymarine certified installer. Installation by persons other than a Raymarine certified installer may invalidate the warranty.

### 1. Product warranty

1.1 Raymarine warrants each new product to be of good materials and workmanship. Raymarine, or its approved agents, will repair or exchange under warranty any parts or product proven to be defective in material or workmanship under normal use, for a period of 2 years (24 months) from date of sale to end user, subject to the limits contained in this warranty document.

1.2 The Raymarine warranty covers the parts and labour associated with any warranty repair as described above, provided that the product is returned to Raymarine or one of its approved agents.

1.3 Raymarine reserve the right to replace under warranty, not repair, certain Raymarine products subject to the limitations below, provided that they are returned to the nearest Raymarine National Distributor. For details of such products refer to the internet at [www.raymarine.com](http://www.raymarine.com) or contact your nearest Raymarine National Distributor.

### 2. Onboard warranty

2.1 In addition to the Product warranty cover as described above, Raymarine will, authorize onboard warranty service by the nearest Raymarine approved service agent, subject to the maximum mileage and other limits referred to in paragraph 4.12 below, on products, where proof of installation, or commission by Raymarine certified installers, can be shown.

2.2 The warranty provides for onboard repair or exchange of the product, by Raymarine or its approved service agents, for a period of 2 years (24 months), subject to the limits contained in this warranty document. In the case of a product installed, by a Raymarine certified OEM installer, on a new boat prior to the sale of the boat to a customer, the 2-year period will begin on the date of the sale of the boat to the customer. In the case of a product installed, by a Raymarine certified installer, on a boat already in the possession of the customer, the 2-year period will begin on the date of the commissioning of the installed product.

2.3 Certain Raymarine products are not covered by onboard warranty unless the products are pre-registered and on board warranty is purchased from the Raymarine certified installer. For details of such products refer to the internet at [www.raymarine.com](http://www.raymarine.com) or contact your nearest Raymarine National Distributor.

2.4 The Purchaseable onboard warranty is subject to the limitations below.

### 3. Obtaining warranty service

3.1 In the event of warranty service being required, the customer should contact Raymarine Technical Support or the nearest Raymarine approved service agent - the contact details of Raymarine Technical Support and a full list of the names and details of worldwide service agents are available on the internet at [www.raymarine.com](http://www.raymarine.com) and in the Owner's Handbook.

3.2 In cases where the customer is requesting a warranty service and a Raymarine certified installer has not installed the product; i.e. Product warranty, the affected product must be returned to the customer's local Raymarine approved service agent or direct to Raymarine with:

- 3.2.1 proof of purchase showing the date of purchase and the name of the supplier of the product; and
- 3.2.2 the serial number of the affected product; or
- 3.2.3 a warranty card completed by the product supplier (which will contain the information required by paragraphs 3.2.1 and 3.2.2).

Subject to the limitations below, the product will be repaired or replaced (at the discretion of Raymarine or a Raymarine Service Agent) at no further cost and promptly returned to the customer.

3.3 In cases where the customer is making a warranty claim and the product has been installed by a Raymarine certified installer, (boat builder, installer, dealer etc.) i.e. Onboard warranty, the nearest Raymarine approved service agent should be contacted and onboard service requested (which will be subject to the limits referred to in paragraph 4.12 below). Before the onboard warranty service is performed, the customer must have available:

- 3.3.1 proof of purchase showing the date of purchase and the name of the supplier of the product; and
- 3.3.2 the serial number of the affected product; or
- 3.3.3 proof of installation of the product by a Raymarine certified installer; or
- 3.3.4 a warranty card completed by the product supplier (which will contain the information required by paragraphs 3.3.1 and 3.3.3).

3.4 In cases where onboard warranty has been purchased - as described in 2.3; the nearest Raymarine approved service agent should be contacted and onboard service requested, information detailed in 3.3.1 and 3.3.2 is required. Onboard warranty service will only be performed if the product serial number confirms that the onboard warranty service has been purchased and is valid.

## **4. Warranty limitations**

4.1 Raymarine warranty policy does not apply to any product that has been subjected to accident, abuse or misuse, shipping damage, alterations, corrosion, incorrect and/or non-authorized service, or products on which the serial number has been altered, mutilated or removed.

4.2 Certain products do not carry the onboard warranty, as described in section 2 above, unless the onboard warranty cover is purchased at the time of installation. The purchaseable onboard warranty is only available on products purchased in specific territories, for further details refer to the internet at [www.raymarine.com](http://www.raymarine.com) or contact your nearest Raymarine National Distributor.

4.3 Products purchased outside the country of installation will not be covered by onboard warranty.

4.4 Raymarine assumes no responsibility for damage incurred during installation or as a result of improper installation.

4.5 This warranty does not cover routine system checkouts, alignment/calibration, sea trials or commissioning, unless required by replacement of part(s) in the area being aligned.

4.6 Raymarine assumes no responsibility for damage caused by or to other equipment, systems or components occasioned by improper or unauthorized connection, or use, of the product.

4.7 Consumable items, including, but not limited to: fuses, batteries, drive belts, radar mixer diodes, snap-in impeller carriers, impellers, impeller bearings, and impeller shafts are specifically excluded from this warranty. A complete list of the consumable items relating to each product can be found in the Owner's Handbook and/or on the internet at [www.raymarine.com](http://www.raymarine.com).

4.8 All costs associated with transducer replacement, other than the cost of the transducer itself, are specifically excluded from this warranty.

4.9 Overtime/premium labour portion of services outside of normal working hours is not covered by this warranty.

4.10 If repairs are necessary under the warranty, the affected product must be forwarded to a Raymarine facility or a Raymarine approved service agent, at the owner's expense.

4.11 The Raymarine warranty does not cover any differences in material, coloring or size between those alluded to in corporate advertising, literature or published on the internet, which are not specifically objected to at the time of delivery.

4.12 Travel costs other than auto mileage, tolls and two (2) hours travel time, are specifically excluded from the warranty on all products. Costs, which are excluded from the coverage of this warranty, include but are not limited to; taxi fares, launch fees, aircraft rental, subsistence, customs, shipping, and communications charges etc.

4.13 Neither Raymarine nor a Raymarine service agent shall be liable for any incidental, indirect, consequential or special (including punitive or multiple) damages, nor shall Raymarine or a Raymarine service agent be liable for any loss of profit, business, contracts, opportunity, goodwill or other similar loss. The liability of Raymarine or a Raymarine service agent to a customer under this warranty, whether for breach of contract, tort, breach of statutory duty or otherwise, shall not exceed US\$1,000,000. Nothing in this paragraph 4.13 shall limit the liability of Raymarine or a Raymarine service agent in respect of death or personal injury caused by its negligence, fraud or any other liability which by law, cannot be excluded or limited.

4.14 All Raymarine products sold or provided hereunder are merely aids to navigation. It is the responsibility of the user to exercise discretion and proper navigational skill independent of any Raymarine product.

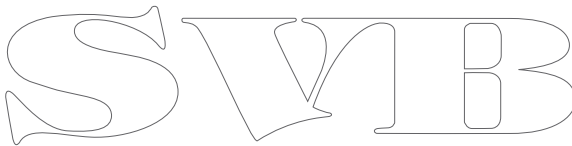

## Raymarine Service Centers

Complete product information and interactive help is available at:  
**[www.raymarine.com](http://www.raymarine.com)**

### North and South America

#### Raymarine Technical Support

1-800-539-5539  
 or, +1 603-881-5200

#### Product Repair and Service

Raymarine Product Repair Center  
 21 Manchester Street,  
 Merrimack,  
 NH 03054-4801  
 USA

### Europe, Middle East, Africa and Australasia

#### Raymarine Technical Support

+44 (0) 23 9271 4713

#### Product Repair and Service

Raymarine plc  
 Anchorage Park  
 Portsmouth  
 PO3 5TD  
 England

### Help us to help you

To allow us to respond to your needs faster, please quote the Equipment type, Model number and Serial number when requesting service

018033-1

Stick barcode label here

Purchased from

Purchase date

Dealer address

Installed by

Installation date

Commissioned by

Commissioning date

Owners name

Mailing address